

Sengbusch

*Catalog
No. 20*

Dedicated to Service



**Sengbusch Self-Closing
Inkstand Company
Milwaukee, Wisconsin, U.S.A.**

"Service"

Sengbusch Service has a double meaning. It applies not only to the true co-operative service that is rendered the dealers of its products, but every device it manufactures and offers to the trade fully exemplifies the word "Service."

Service is defined as labor for the benefit of another. The amount of good we render to mankind determines its worth.

From a small beginning, we have built up an organization whose products reach to all parts of the world. Our devices are such that they contribute to the efficiency and successful operation of business institutions, and as such, they are welcome everywhere.

Not only is it our earnest endeavor to give prompt and efficient attention to each order as it is received, but we are not content until the merchandise we sell you has reached the ultimate consumer and gives utmost satisfaction.

To this end we render a service of help in merchandising, through timely and effective publicity, window cards, mailing folders and other mediums.

It is a satisfaction to us and to our dealers that every sale of a "Sengbusch" item means a satisfied customer.

Sengbusch

Self Closing Inkstand

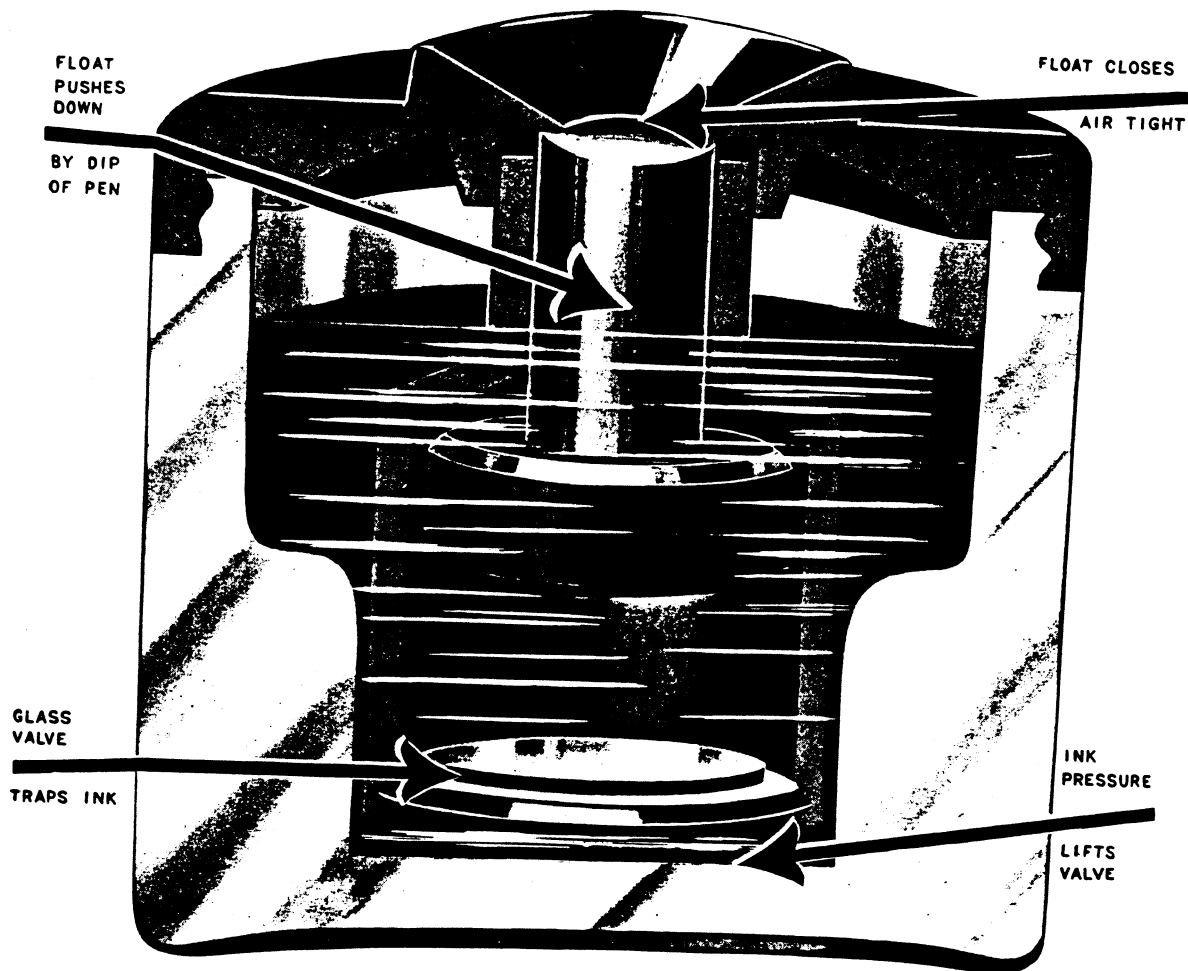

SECTIONAL VIEW

Showing "Sengbusch" Inkstand Closed Air-tight (same as corked bottle) when Pen is Withdrawn.

Ten Good Reasons for This Inkstand

- 1st. You always get clean, fresh ink — inkstand closes air-tight (same as cork in bottle).
- 2nd. Absolutely no evaporation of ink — you save 75 per cent of your ink bills.
- 3rd. Can be maintained on the desk of your busiest clerk with only 8 ounces of ink during year. **THINK THIS OVER.**
- 4th. No funnels above top surface of well — ink never spurts out.
- 5th. Your pen is dipped to a uniform depth — no overloaded pens, causing ink blots.
- 6th. Requires filling once in two to six months' actual use. Other stands require filling 52 times a year.
- 7th. Requires cleaning inside once a year.
- 8th. Saves pen points — no corrosion from ink.
- 9th. Prevents evaporation of red ink, and works perfectly with copying ink.
- 10th. Saves time and trouble.

During the years that Sengbusch Self-Closing Inkstands have been in use, many critical tests have been made by banks and court houses in the remotest hamlets, as well as by the best organized efficiency and economy departments in some of the largest, nationally-known institutions. Invariably the facts as based on comparative tests have shown that with the ordinary inkstand there is a waste of 50% to 75% of the ink by dust and evaporation. A careful check of the ink bills discloses the fact that the saving effected by Seng-

busch Inkstands is sufficient to return their entire cost the first year, and every year thereafter Sengbusch Inkstands return 100% on the dollar. This annual dividend will continue indefinitely, because Sengbusch Inkstands are made of glass and hard rubber and will, saying the least, last a business man's lifetime. These are times when executives are seeking to prevent all waste. In the Sengbusch Inkstand a device is offered which stops waste and goes on paying dividends for years.

Sengbusch

Single Inkstands



"Sengbusch" Inkstands in your office mean the highest efficiency in inkstand service. Try one and be convinced.
All single inkstands come with black caps unless otherwise ordered. Red caps may be had if specified.



No. 51 — Plain Glass, 3 in. diameter, 3 in. high.

This style is made up only in one number. The top screws onto the glass.

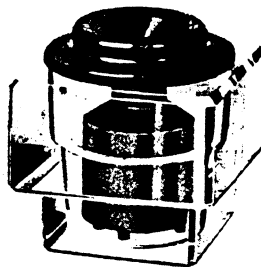

Cut Glass Square Countersunk Inkstands

No. 52M	No. 52F	
3 in.	3 in.	Over-all height.
2-1/16 in.	2 3/8 in.	Height above desk level.
15/16 in.	5/8 in.	Height below desk level.
2 3/4 in.	3 in.	Square above desk level.
2-5/16 in.	2 3/4 in.	Square below desk level.

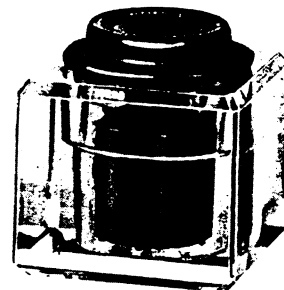

No. 52	—	Cut Glass,	3	in. square,	3	in. high.
No. 53	—	Plain	3	" "	3	" "
No. 54	—	Cut	3 1/2	" "	3	" "
No. 54a	—	"	4	" "	3	" "

In all these numbers, also in No. 57, a hard rubber collar is permanently set into the glass and the top plugs into this collar. No. 52 may be had cut down to either 2 1/2 inches, 2 3/4 inches, 2 7/8 inches, or 2 9/8 inches at 50c extra.

Home and Office Special

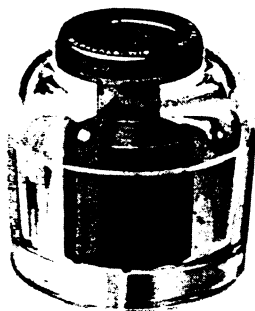

No. 55 — Plain Glass, 3 in. diam., 3 in. high.
No. 61 — " " 2 1/2 " " 3 " "

These two numbers are made up as illustrated. The only difference is in their diameter. The height of both numbers is the same. The top plugs into the glass.



No. 62 — Plain Glass, 2 1/2 in. diam., 2 1/2 in. high.

These little inkwells possess the same Self-Closing features as all other "Sengbusch" Inkstands, yet are constructed differently. In the regular "Sengbusch" commercial stands the hard rubber buoyant float is incased in a hard rubber casing, commonly termed the "fountain." In the Nos. 62, 63 and 64 this same float operates in a glass sleeve set in a cork gasket. The Nos. 62, 63 and 64 are bought chiefly where space does not permit using the larger "Sengbusch" stands; otherwise the latter are preferred.

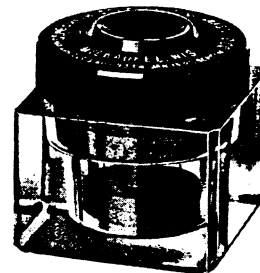

No. 63 — Plain Glass, 2 1/2 in. sq., 2 1/2 in. high.
No. 64 — Cut " " 2 1/2 " " 2 1/2 " "

Countersunk Inkstands

These inkstands set into round hole in desk or in bases as shown on the following pages.



No. 56 — Plain Glass, 2 3/4 in. diameter.
No. 60 — " " 3 " " "

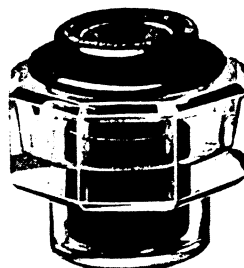

No. 57 — Cut Glass, 3 in. Octagon.

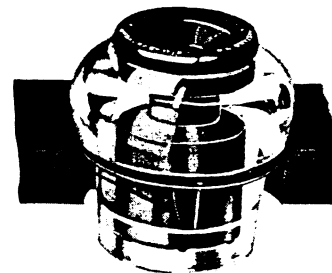

No. 58 — Same as No. 56, with lock.
No. 60 — " " No. 60, " "

On all Countersunk Inkstands the over-all height is 3 inches. The height of the part below the desk level is 1 1/4 inches on Nos. 56, 58 and 60, and 1 inch on No. 57. The diameter of the part below the desk level is 2 3/4 inches on all countersunk inkstands.

Sengbusch

Emeraline Base Sets



Made from Selected Quality Plate Glass—Hand Cut and Highly Polished.

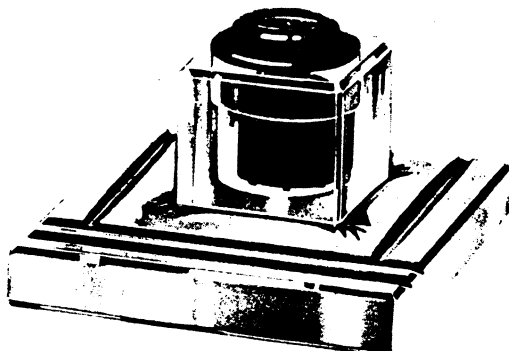

Above Illustrates No. 200

No. 200 — 1 in. thick Single Desk Base, with one No. 52.
No. 204 — $\frac{1}{2}$ " " " " " " " " " " " " No. 52.
Size of Base $6\frac{1}{2}$ x $6\frac{1}{2}$ in.

No. 201 — 1 in. thick Double Desk Base, with one No. 52.
No. 205 — $\frac{1}{2}$ " " " " " " " " " " " " No. 52.
Size of Base 7 x 9 in.

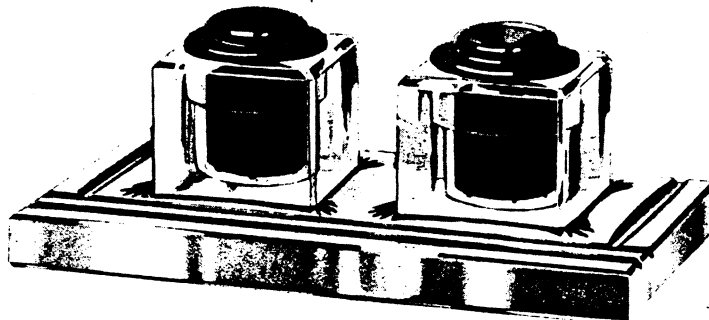

Above Illustrates No. 210

No. 210 — 1 in. thick Single Desk Base, with two No. 52.
No. 214 — $\frac{1}{2}$ " " " " " " " " " " " " No. 52.
Size of Base 6 x 11 in.

No. 211 — 1 in. thick Double Desk Base, with two No. 52.
No. 215 — $\frac{1}{2}$ " " " " " " " " " " " " No. 52.
Size of Base 8 x 11 in.

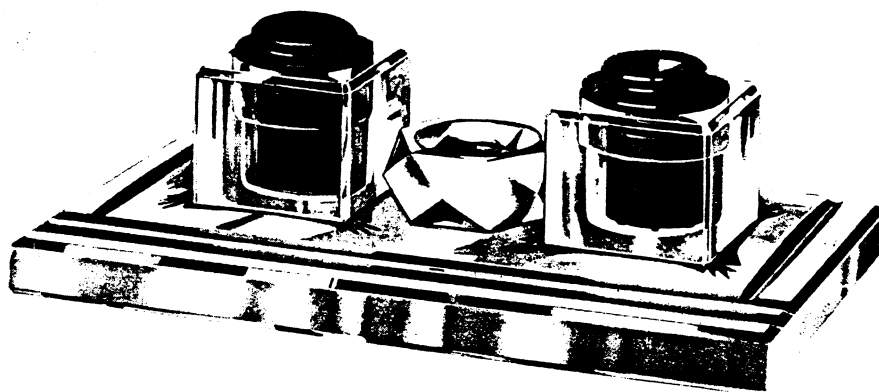

Above Illustrates No. 220

*No. 220 — 1 in. thick Single Desk Base, with two No. 52.
*No. 224 — $\frac{1}{2}$ " " " " " " " " " " " " No. 52.
Size of Base $6\frac{1}{2}$ x 12 in.

*No. 221 — 1 in. thick Double Desk Base, with two No. 52.
*No. 225 — $\frac{1}{2}$ " " " " " " " " " " " " No. 52.
Size of Base 9 x $13\frac{1}{4}$ in.

*Includes Cut Glass Pin Cup.

"Sengbusch" Emeraline Base Sets are very attractive, and add materially to the effect of a well-equipped office. No first-class office equipment is complete without them.

Felt Mats with Pinked Edges may be had in Green, Brown and Maroon colors for all Bases on this page. See price list.

Sengbush

Emeraline Base Sets



High-Grade Cut and Polished Plate Glass — Hand Cut and Highly Polished.

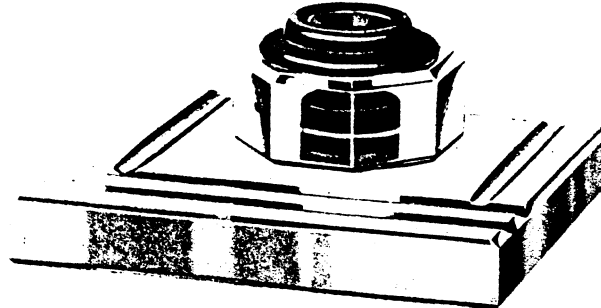

Above Illustrates No. 202

No. 202 — 1 in. thick Single Desk Base, with one No. 57.
Size of Base $6\frac{1}{2}$ x $6\frac{1}{2}$ in.

No. 203 — 1 in. thick Double Desk Base, with one No. 57.
Size of Base 7 x 9 in.

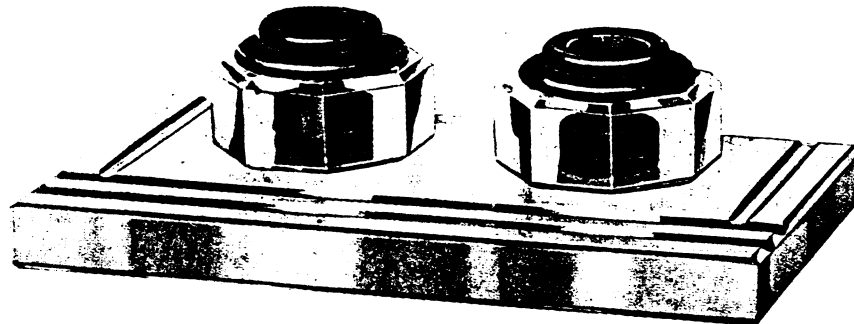

Above Illustrates No. 212

No. 212 — 1 in. thick Single Desk Base, with two No. 57.
Size of Base 6 x 11 in.

No. 213 — 1 in. thick Double Desk Base, with two No. 57.
Size of Base 8 x 11 in.

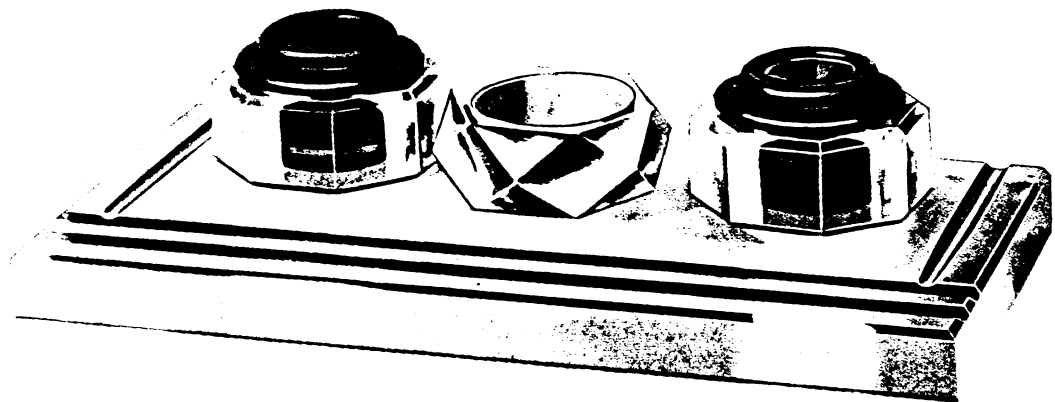

Above Illustrates No. 222

*No. 222 — 1 in. thick Single Desk Base, with two No. 57.
Size of Base $6\frac{1}{2}$ x 12 in.

*No. 223 — 1 in. thick Double Desk Base, with two No. 57.
Size of Base 9 x $13\frac{1}{4}$ in.

*Includes Cut Glass Pin Cup.

Black Polished Plate Glass Bases

The six styles listed on this page, and the six styles listed on page 7 can be furnished with Black Polished Plate Glass Bases at prices indicated, plus 25% additional on price of Bases.

Felt Mats with Pinked Edges may be had in Green, Brown and Maroon colors for all Bases on this page. See price list.

Emeraline Base Sets



Classy Oval Designs with Two Oval Scooped Pin Cups in Each Base.

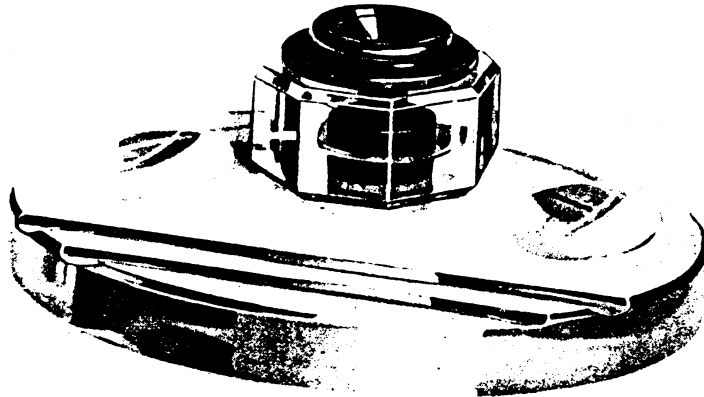

Above Illustrates No. 206

No. 206 — 1 in. thick Single Desk Base, with one No. 57.
Size of Base 7 x 9 in.

No. 207 — 1 in. thick Double Desk Base, with one No. 57.
Size of Base 7¼ x 9½ in.

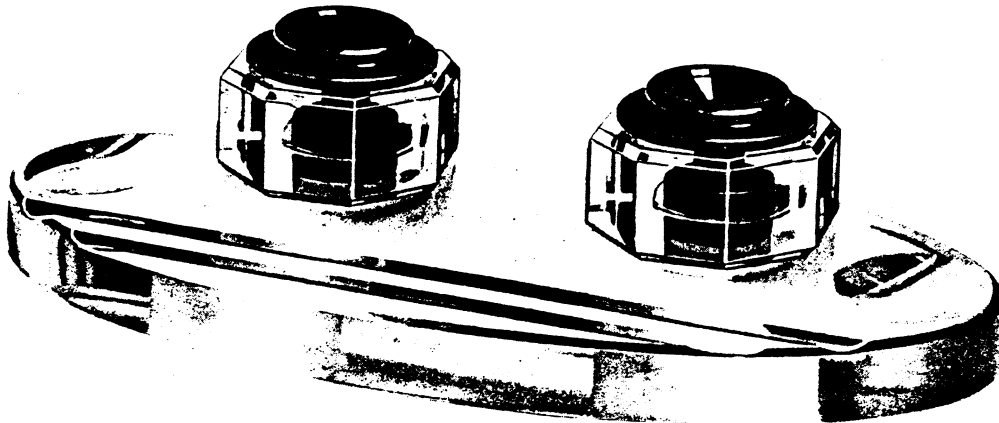

Above Illustrates No. 216

No. 216 — 1 in. thick Single Desk Base, with two No. 57.
Size of Base 7 x 13½ in.

No. 217 — 1 in. thick Double Desk Base, with two No. 57.
Size of Base 9 x 13½ in.

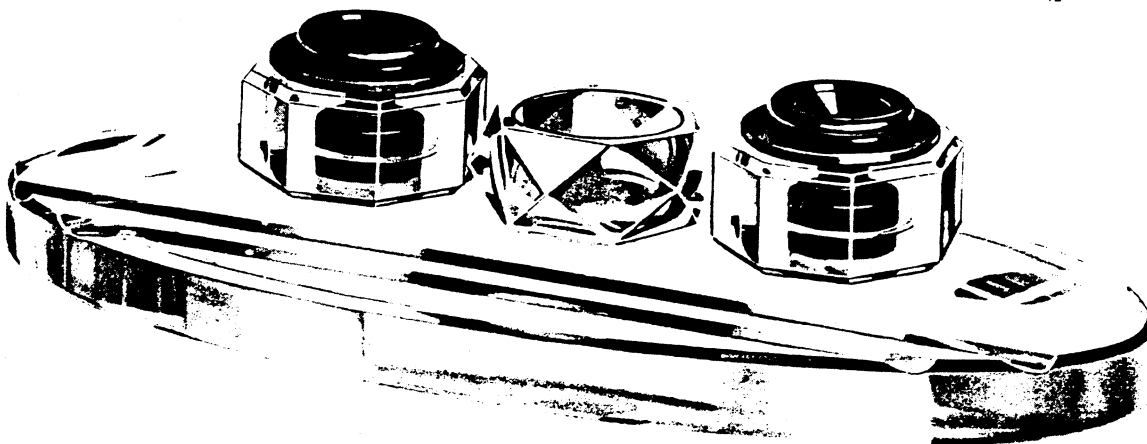

Above Illustrates No. 226

*No. 226 — 1 in. thick Single Desk Base, with two No. 57.
Size of Base 7 x 16 in.

*No. 227 — 1 in. thick Double Desk Base, with two No. 57.
Size of Base 9½ x 16 in.

*Includes Cut Glass Pin Cup.

Felt Mats with Pinked Edges may be had in Green, Brown and Maroon colors for all Bases on this page. See price list.

Singmaster

Emeraline Base Sets

Distinct Oval Designs with One Wide (1-inch) Pen Groove.

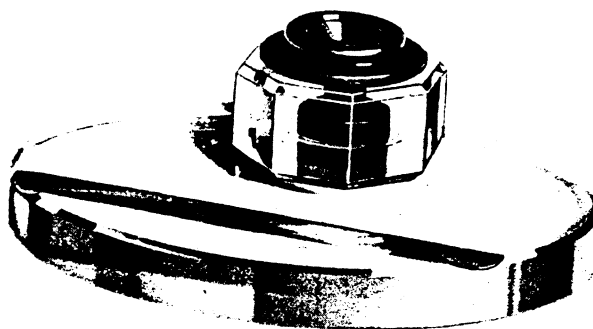

Above Illustrates No. 208

No. 208 — 1 in. thick Single Desk Base, with one No. 57.
Size of Base 7 x 9 in.

No. 209 — 1 in. thick Double Desk Base, with one No. 57.
Size of Base 7½ x 9½ in.

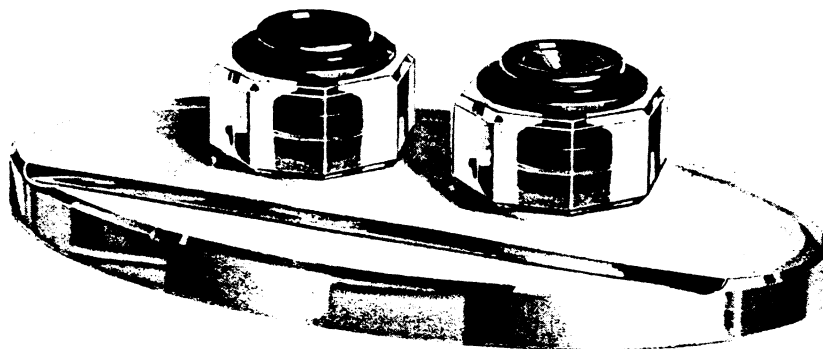

Above Illustrates No. 218

No. 218 — 1 in. thick Single Desk Base, with two No. 57.
Size of Base 7 x 13½ in.

No. 219 — 1 in. thick Double Desk Base, with two No. 57.
Size of Base 9 x 13½ in.



Above Illustrates No. 228

*No. 228 — 1 in. thick Single Desk Base, with two No. 57.
Size of Base 7 x 16 in.

*No. 229 — 1 in. thick Double Desk Base, with two No. 57.
Size of Base 9½ x 16 in.

*Includes Cut Glass Pin Cup.

Felt Mats with Pinked Edges may be had in Green, Brown and Maroon colors for all Bases on this page. See price list.

Songbusch's

Emeraline Base Sets



Handsome Oval Bases, with Two Oval Scooped Pin Cups in Each Base.

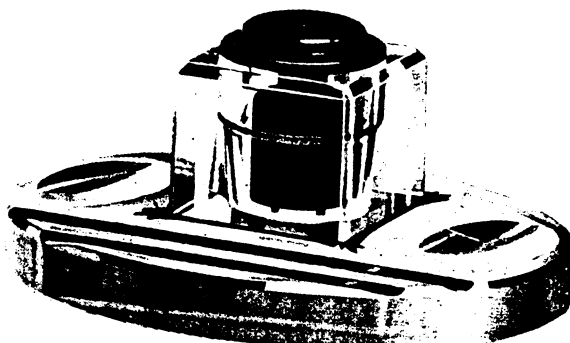

Above Illustrates No. 270

No. 270 — 1 in. thick Single Desk Base, with one No. 52.
No. 280 — ½ " " " " " " " " No. 52.
Size of Base 7 x 9 in.

No. 271 — 1 in. thick Double Desk Base, with one No. 52.
No. 281 — ½ " " " " " " " " No. 52.
Size of Base 7¾ x 9½ in.

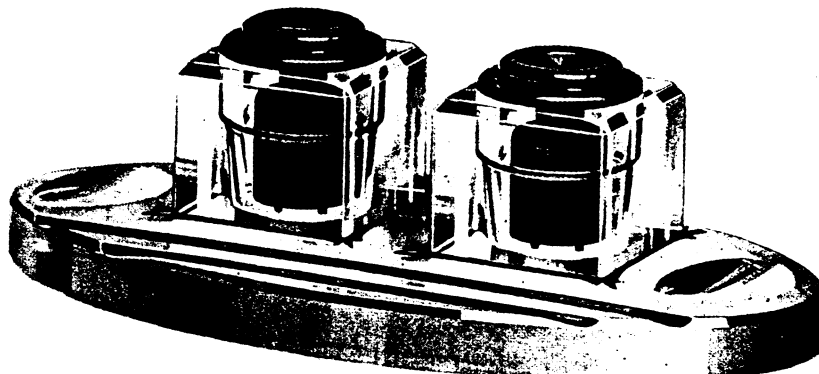

Above Illustrates No. 272

No. 272 — 1 in. thick Single Desk Base, with two No. 52.
No. 282 — ½ " " " " " " " " No. 52.
Size of Base 7 x 13½ in.

No. 273 — 1 in. thick Double Desk Base, with two No. 52.
No. 283 — ½ " " " " " " " " No. 52.
Size of Base 9 x 13½ in.

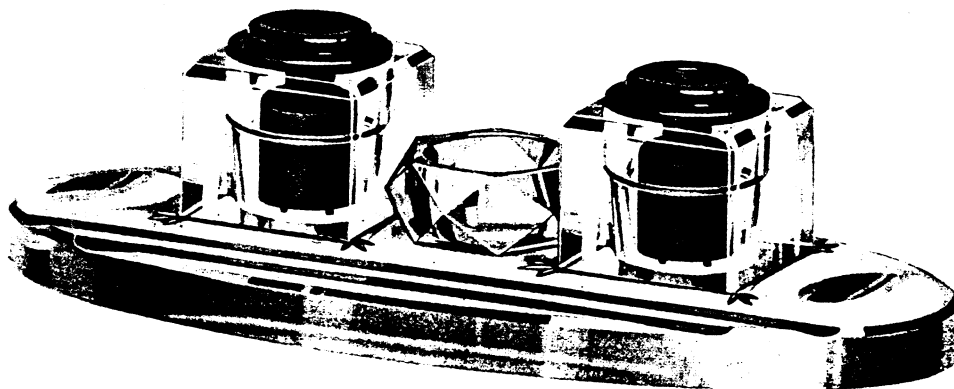

Above Illustrates No. 274

*No. 274 — 1 in. thick Single Desk Base, with two No. 52.
*No. 284 — ½ " " " " " " " " No. 52.
Size of Base 7 x 16 in.

*No. 275 — 1 in. thick Double Desk Base, with two No. 52.
*No. 285 — ½ " " " " " " " " No. 52.
Size of Base 9½ x 16 in.

*Includes Cut Glass Pin Cup.

Felt Mats with Pinked Edges may be had in Green, Brown and Maroon colors for all Bases on this page. See price list.

Sengbusch

Emeraline Base Sets



Very Attractive Bases with Cut-off Corners.

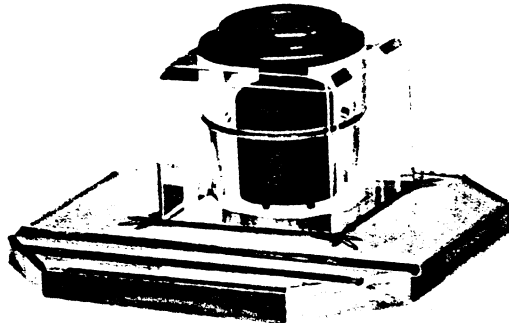

Above Illustrates No. 340, 1/2 In. Thick Base

No. 330 — 1 in. thick Single Desk Base, with one No. 52.
No. 340 — 1/2 " " " " " " " " No. 52.
No. 350 — 1 " " " " " " " " No. 57.
Size of Base 6 1/2 x 6 1/2 in.

No. 331 — 1 in. thick Double Desk Base, with one No. 52.
No. 341 — 1/2 " " " " " " " " No. 52.
No. 351 — 1 " " " " " " " " No. 57.
Size of Base 7 x 9 in.

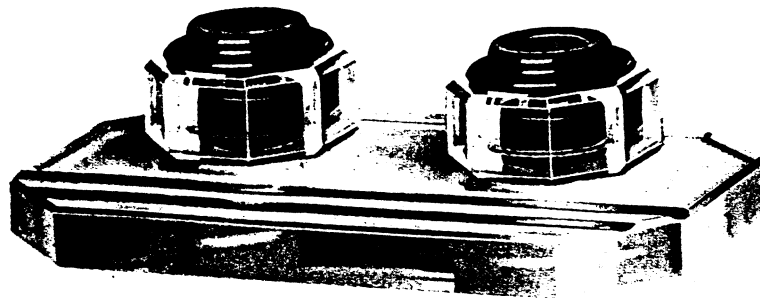

Above Illustrates No. 352, 1 In. Thick Base

No. 332 — 1 in. thick Single Desk Base, with two No. 52.
No. 342 — 1/2 " " " " " " " " No. 52.
No. 352 — 1 " " " " " " " " No. 57.
Size of Base 6 x 11 in.

No. 333 — 1 in. thick Double Desk Base, with two No. 52.
No. 343 — 1/2 " " " " " " " " No. 52.
No. 353 — 1 " " " " " " " " No. 57.
Size of Base 8 x 11 in.

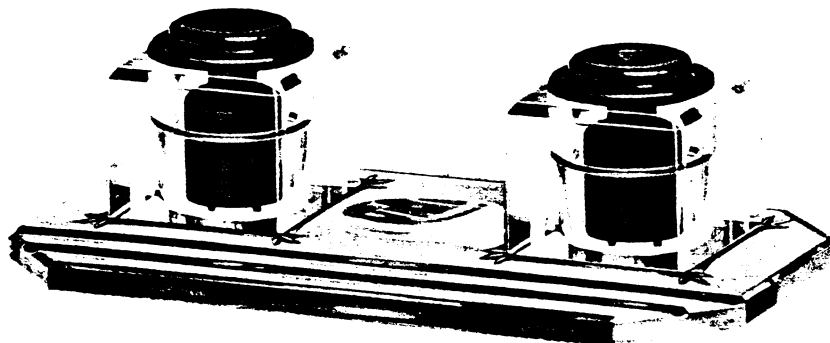

Above Illustrates No. 344, 1/2 In. Thick Base

*No. 334 — 1 in. thick Single Desk Base, with two No. 52.
*No. 344 — 1/2 " " " " " " " " No. 52.
*No. 354 — 1 " " " " " " " " No. 57.
Size of Base 6 1/2 x 12 in.

*No. 335 — 1 in. thick Double Desk Base, with two No. 52.
*No. 345 — 1/2 " " " " " " " " No. 52.
*No. 355 — 1 " " " " " " " " No. 57.
Size of Base 9 x 13 1/4 in.

*With Oval Scooped Pin Cup.

Felt Mats with Pinked Edges may be had in Green, Brown and Maroon colors for all Bases on this page. See price list.

Emeraline Base Sets



Practical and Popular Emeraline Base Sets.

Especially adapted for Bank Counters, Low Roll-top Desks, etc., where a 4½-inch wide Base is an advantage. Also very applicable for Double Desk use.

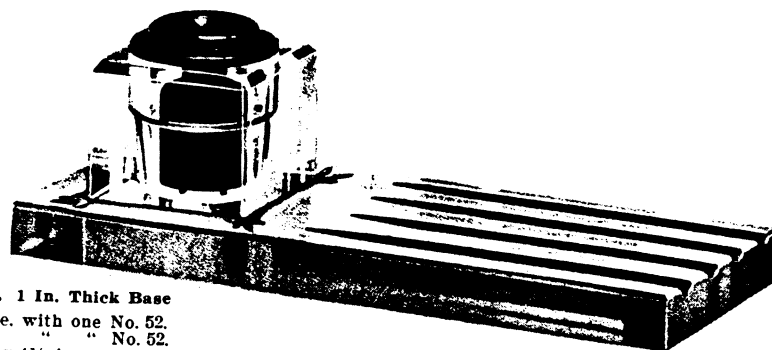

Above Illustrates No. 360. 1 In. Thick Base
 No. 360 — 1 in. thick Base, with one No. 52.
 No. 362 — ½ " " " " " No. 52.
 Size of Base 12 x 4½ in.

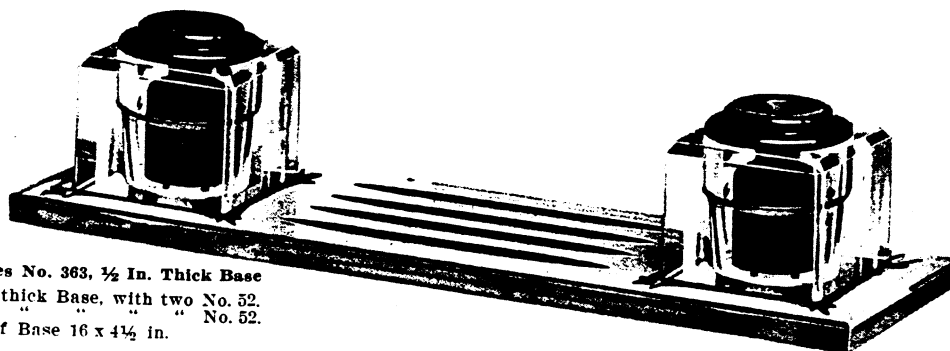

Above Illustrates No. 363. ½ In. Thick Base
 No. 361 — 1 in. thick Base, with two No. 52.
 No. 363 — ½ " " " " " No. 52.
 Size of Base 16 x 4½ in.

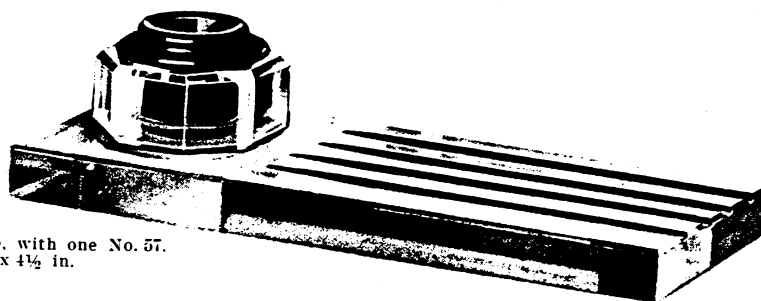

No. 364 — 1 in. thick Base, with one No. 57.
 Size of Base 12 x 4½ in.

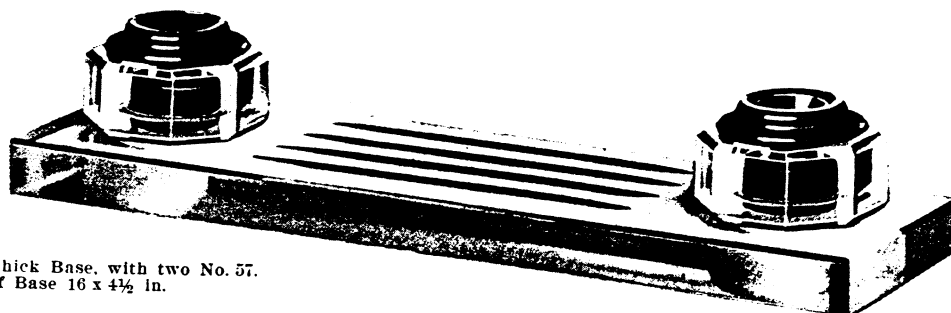

No. 366 — 1 in. thick Base, with two No. 57.
 Size of Base 16 x 4½ in.

NOTE — Any of the Emeraline Bases, pages 5 to 12 inclusive, may be had 1¼ inch thick, which adds 20% to the price given, or 1½ inch thick, which adds 30% to the price given.

Felt Mats with Pinked Edges may be had in Green, Brown and Maroon colors for all Bases on this page. See price list.

Sengbusch

Emeraline Base Sets



Emeraline Bases for No. 51 and No. 55 "Sengbusch" Inkstands.

Made of 1/2-inch Thick Plate Glass.

As the Nos. 51 and 55 Inkstands are the same diameter, the same Bases apply for both Inkstands. When ordering Sets, specify whether No. 51 or No. 55 Inkstand is wanted.

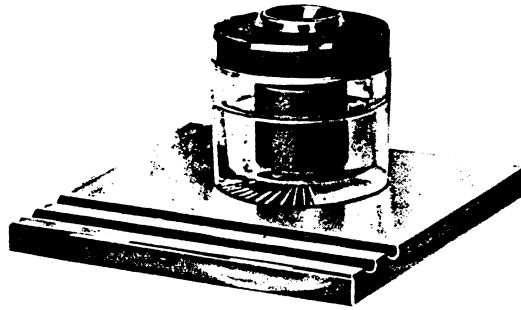

Above Illustrates No. 370, with No. 51

- No. 370 — Single Desk Base, Size $6\frac{1}{2} \times 6\frac{1}{2}$ in., with one No. 51 or No. 55.
No. 372 — " " " " 6×11 " " two No. 51 " No. 55.
*No. 374 — " " " " $6\frac{1}{2} \times 12$ " " two No. 51 " No. 55.

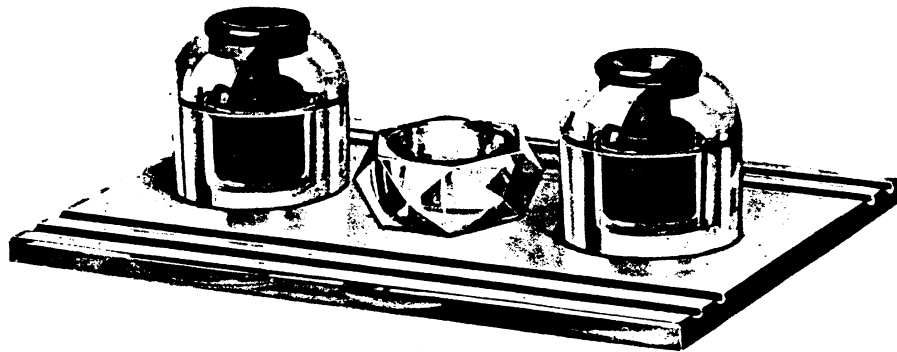

Above Illustrates No. 375, Double Desk, with No. 55

- No. 371 — Double Desk Base, Size 7×9 in., with one No. 51 or No. 55.
No. 373 — " " " " 8×11 " " two No. 51 " No. 55.
*No. 375 — " " " " $9 \times 13\frac{1}{4}$ " " two No. 51 " No. 55.
*Includes Cut Glass Pin Cup.

Something Real Swell for Executives' Offices, Bankers' Desks and Directors' Tables.

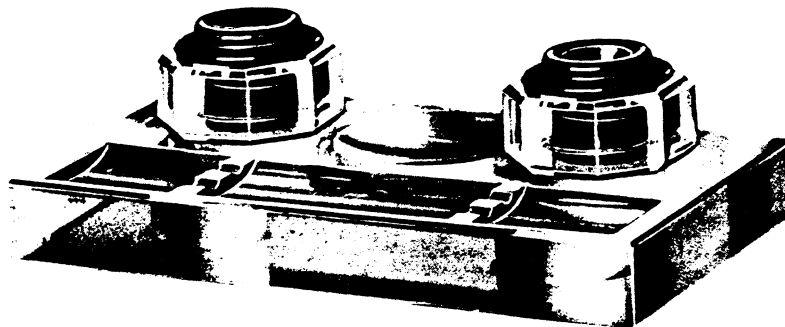

Above Illustrates No. 500

- No. 500 — $1\frac{1}{2}$ in. thick Single Desk Base, Size $12 \times 6\frac{1}{2}$ in., with two No. 57.
No. 501 — $1\frac{1}{2}$ " " Double " " $13\frac{1}{2} \times 10$ " " two No. 57.

In addition to the varied assortment shown on preceding pages, we are equipped to make promptly Special Designs of any size or thickness of Emeraline Plate Glass Bases desired.

Felt Mats with Pinked Edges may be had in Green, Brown and Maroon colors for all Bases on this page. See price list.

Sengbusch's

Colonial Base Sets - Oak Mahogany Walnut



With No. 52 Cut Glass Inkstand.

All our Colonial Bases are made of select quarter-sawed oak, genuine mahogany, or genuine walnut, and are finished to match the prevailing colors now put out by leading desk manufacturers.

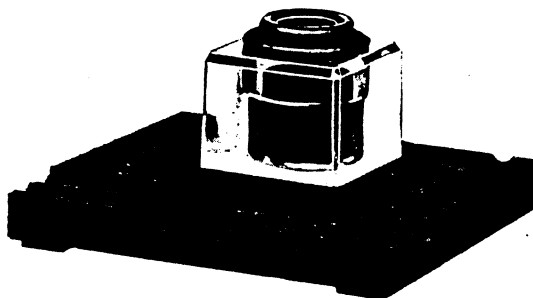

Above Illustrates Nos. 401, 402 and 405

- No. 401 — Oak Base for Single Desk, with one No. 52.
- No. 402 — Mah. " " " " " " " " No. 52.
- No. 405 — Wal. " " " " " " " " No. 52.

Size of Base $6\frac{3}{4} \times 7\frac{3}{4} \times 1\frac{1}{2}$ in.

- No. 403 — Oak Base for Double Desk, with one No. 52.
- No. 404 — Mah. " " " " " " " " No. 52.
- No. 406 — Wal. " " " " " " " " No. 52.

Size of Base $8\frac{3}{4} \times 7\frac{3}{4} \times 1\frac{1}{2}$ in.

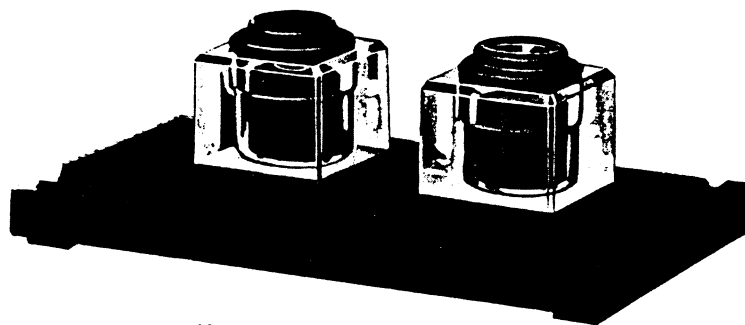

Above Illustrates Nos. 411, 412 and 415

- No. 411 — Oak Base for Single Desk, with two No. 52.
- No. 412 — Mah. " " " " " " " " No. 52.
- No. 415 — Wal. " " " " " " " " No. 52.

Size of Base $6\frac{3}{4} \times 13\frac{1}{4} \times 1\frac{1}{2}$ in.

- No. 413 — Oak Base for Double Desk, with two No. 52.
- No. 414 — Mah. " " " " " " " " No. 52.
- No. 416 — Wal. " " " " " " " " No. 52.

Size of Base $8\frac{3}{4} \times 13\frac{1}{4} \times 1\frac{1}{2}$ in.

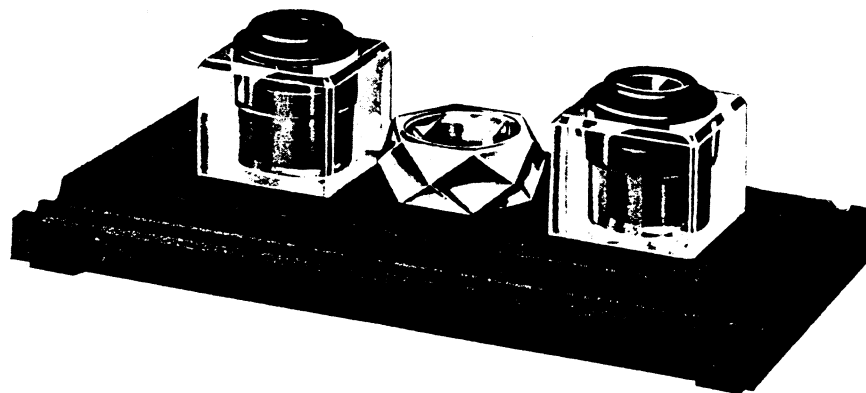

Above Illustrates Nos. 421, 422 and 425

- *No. 421 — Oak Base for Single Desk, with two No. 52.
- *No. 422 — Mah. " " " " " " " " No. 52.
- *No. 425 — Wal. " " " " " " " " No. 52.

Size of Base $7\frac{3}{4} \times 15 \times 1\frac{1}{2}$ in.

- *No. 423 — Oak Base for Double Desk, with two No. 52.
- *No. 424 — Mah. " " " " " " " " No. 52.
- *No. 426 — Wal. " " " " " " " " No. 52.

Size of Base $9\frac{3}{4} \times 15 \times 1\frac{1}{2}$ in.

*Includes Cut Glass Pin Cup.

NOTE — Wherever No. 52 is illustrated and listed with Bases, No. 53 plain glass Well may be substituted at 25 cents less for each Well.

Sengbusch's

Colonial Base Sets - Oak Mahogany Walnut



With No. 57 Cut Glass Inkstand.

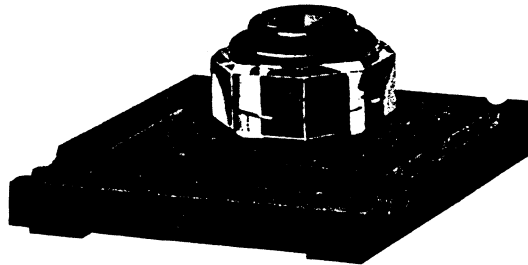

Above Illustrates Nos. 431, 432 and 435

- No. 431 — Oak Base for Single Desk, with one No. 57.
 - No. 432 — Mah. " " " " " " No. 57.
 - No. 435 — Wal. " " " " " " No. 57.
- Size of Base 6¼ x 6¼ x 1¾ in.

- No. 433 — Oak Base for Double Desk, with one No. 57
 - No. 434 — Mah. " " " " " " No. 57
 - No. 436 — Wal. " " " " " " No. 57
- Size of Base 8¼ x 6¼ x 1¾ in.

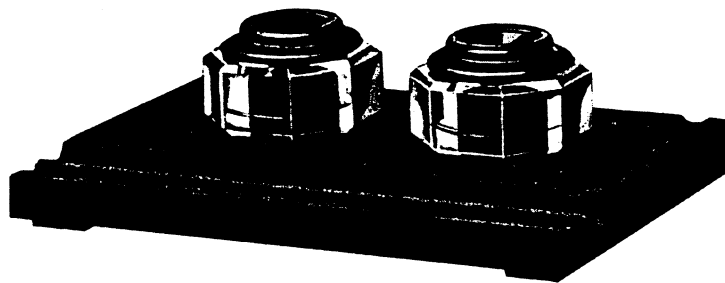

Above Illustrates Nos. 441, 442 and 445

- No. 441 — Oak Base for Single Desk, with two No. 57.
 - No. 442 — Mah. " " " " " " No. 57.
 - No. 445 — Wal. " " " " " " No. 57.
- Size of Base 6¼ x 11 x 1¾ in.

- No. 443 — Oak Base for Double Desk, with two No.
 - No. 444 — Mah. " " " " " " No.
 - No. 446 — Wal. " " " " " " No.
- Size of Base 8¼ x 11 x 1¾ in.



Above Illustrates Nos. 451, 452 and 455

- *No. 451 — Oak Base for Single Desk, with two No. 57.
 - *No. 452 — Mah. " " " " " " No. 57.
 - *No. 455 — Wal. " " " " " " No. 57.
- Size of Base 7¼ x 13½ x 1¾ in.

- *No. 453 — Oak Base for Double Desk, with two
 - *No. 454 — Mah. " " " " " "
 - *No. 456 — Wal. " " " " " "
- Size of Base 9¼ x 13½ x 1¾ in.

*Includes Cut Glass Pin Cup.

NOTE — Wherever No. 57 is illustrated and listed with Bases, No. 56 or No. 60 Plain Glass Well may be substituted at 50 cents less for each Well.

Standard Base Sets-Oak and Mahogany



Standard Base Sets, with No. 56 Inkstand.

Our Standard Bases are all made of the best quarter-sawed oak or genuine mahogany finished to match the prevailing colors on desks, same as our Colonial line.

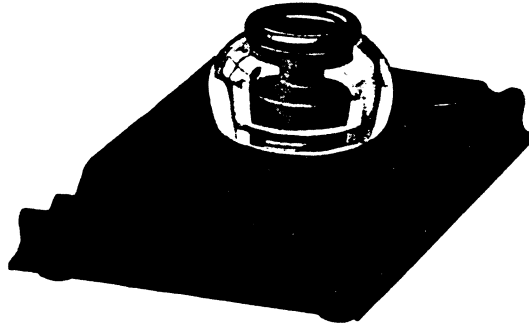

Above Illustrates Nos. 131 and 132

No. 131 — Oak Base for Single Desk, with one No. 56.
 No. 132 — Mah. " " " " " " " " No. 56.
 Size of Base $5\frac{1}{4} \times 6 \times 1\frac{1}{8}$ in.

No. 133 — Oak Base for Double Desk, with one No. 56.
 No. 134 — Mah. " " " " " " " " No. 56.
 Size of Base $7\frac{1}{2} \times 6 \times 1\frac{1}{8}$ in.

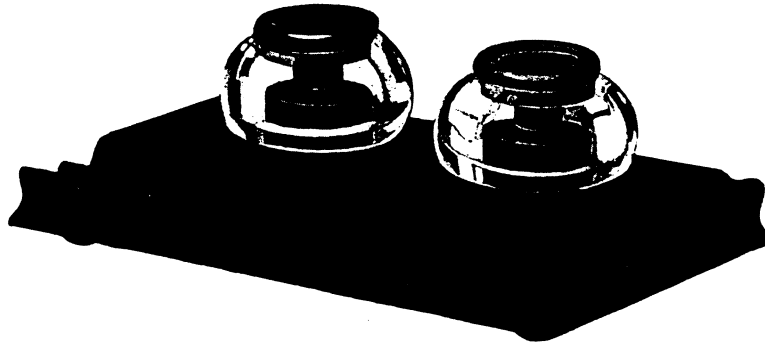

Above Illustrates Nos. 141 and 142

No. 141 — Oak Base for Single Desk, with two No. 56.
 No. 142 — Mah. " " " " " " " " No. 56.
 Size of Base $5\frac{1}{4} \times 10 \times 1\frac{1}{8}$ in.

No. 143 — Oak Base for Double Desk, with two No. 56.
 No. 144 — Mah. " " " " " " " " No. 56.
 Size of Base $7\frac{1}{2} \times 10 \times 1\frac{1}{8}$ in.

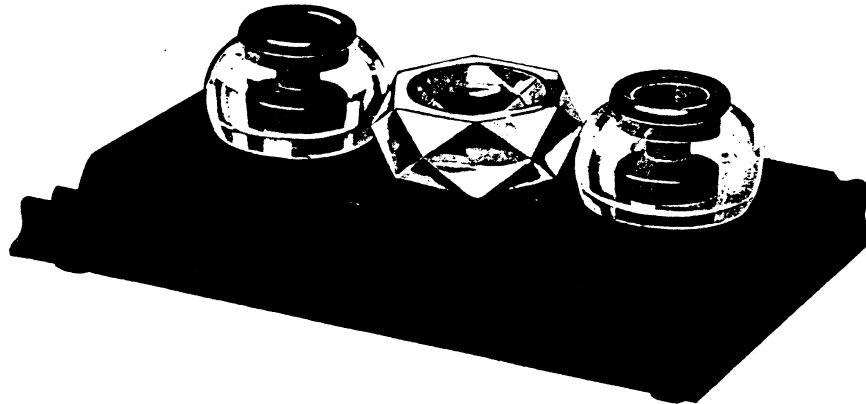

Above Illustrates Nos. 151 and 152

*No. 151 — Oak Base for Single Desk, with two No. 56.
 *No. 152 — Mah. " " " " " " " " No. 56.
 Size of Base $6\frac{1}{2} \times 12 \times 1\frac{1}{8}$ in.

*No. 153 — Oak Base for Double Desk, with two No. 56.
 *No. 154 — Mah. " " " " " " " " No. 56.
 Size of Base $8\frac{1}{2} \times 12 \times 1\frac{1}{8}$ in.

*Includes Pressed Glass Pin Cup.

NOTE — Wherever No. 56 is illustrated and listed with Bases, No. 60 may be substituted without extra cost; and No. 57 may be substituted at 50 cents additional for each Well.

Bases Nos. 131 to 154 inclusive may also be had with receptacles suitable for No. 62 Inkstand.

Sengbusch

Standard Base Sets-Oak and Mahogany



With No. 51 or No. 55 Plain Glass Inkstand and No. 52 Cut Glass Inkstand.

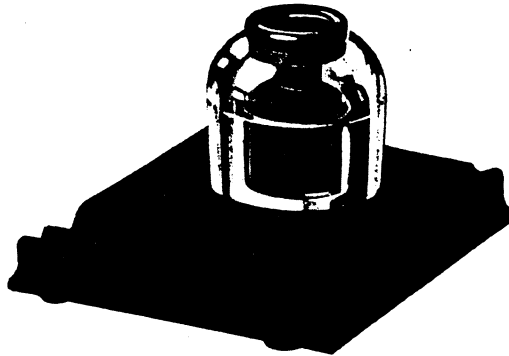

Above Illustrates Nos. 105 and 106 with No. 52 Inkstand

- No. 101 — Oak Base for Single Desk, with one No. 52.
- No. 103 — Mah. " " " " " " No. 52.
- No. 105 — Oak " " " " " " No. 51 or No. 55.
- No. 106 — Mah. " " " " " " No. 51 " No. 55.

Size of Base $6\frac{1}{4} \times 6\frac{1}{4} \times 1\frac{1}{8}$ in.

- No. 102 — Oak Base for Double Desk, with one No. 52.
- No. 104 — Mah. " " " " " " No. 52.
- No. 107 — Oak " " " " " " No. 51 or No. 55.
- No. 108 — Mah. " " " " " " No. 51 " No. 55.

Size of Base $8\frac{1}{4} \times 6\frac{1}{4} \times 1\frac{1}{8}$ in.

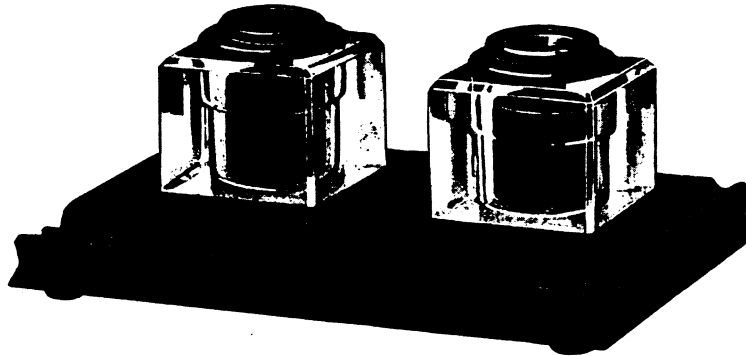

Above Illustrates Nos. 111 and 113, with No. 52 Inkstand

- No. 111 — Oak Base for Single Desk, with two No. 52.
- No. 113 — Mah. " " " " " " No. 52.
- No. 115 — Oak " " " " " " No. 51 or No. 55.
- No. 116 — Mah. " " " " " " No. 51 " No. 55.

Size of Base $6\frac{1}{4} \times 11 \times 1\frac{1}{8}$ in.

- No. 112 — Oak Base for Double Desk, with two No. 52.
- No. 114 — Mah. " " " " " " No. 52.
- No. 117 — Oak " " " " " " No. 51 or No. 55.
- No. 118 — Mah. " " " " " " No. 51 " No. 55.

Size of Base $8\frac{1}{4} \times 11 \times 1\frac{1}{8}$ in.

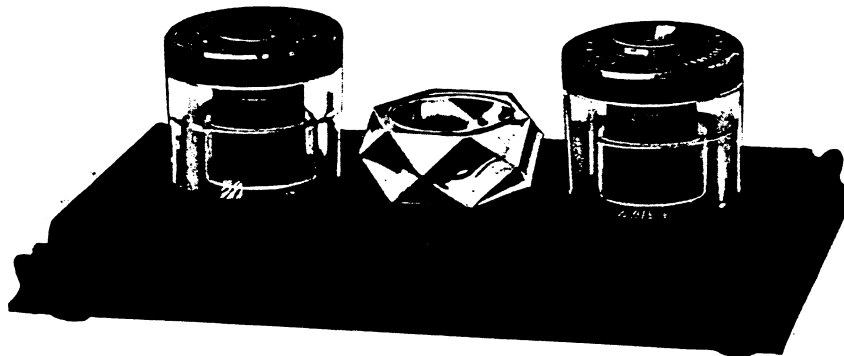

Above Illustrates Nos. 125 and 126 with No. 51 Inkstand

- *No. 121 — Oak Base for Single Desk, with two No. 52.
- *No. 123 — Mah. " " " " " " No. 52.
- †No. 125 — Oak " " " " " " No. 51 or No. 55.
- †No. 126 — Mah. " " " " " " No. 51 " No. 55.

Size of Base $7\frac{1}{4} \times 13\frac{1}{4} \times 1\frac{1}{8}$ in.

- *No. 122 — Oak Base for Double Desk, with two No. 52.
- *No. 124 — Mah. " " " " " " No. 52.
- †No. 127 — Oak " " " " " " No. 51 or No. 55.
- †No. 128 — Mah. " " " " " " No. 51 " No. 55.

Size of Base $9\frac{1}{4} \times 13\frac{1}{4} \times 1\frac{1}{8}$ in.

As the Nos. 51 and 55 Inkstands are the same diameter, the same Bases apply for both Inkstands. When ordering Sets specify whether No. 51 or No. 55 Inkstand is wanted.

*Includes Cut Glass Pin Cup. †Includes Pressed Glass Pin Cup.

NOTE — Wherever No. 52 is illustrated with Bases, No. 53 Plain Glass may be substituted at 25 cents less for each Well.

Pressed Glass Base Sets



With No. 56 Inkstand.

A Highly Attractive Base at a Moderate Price.

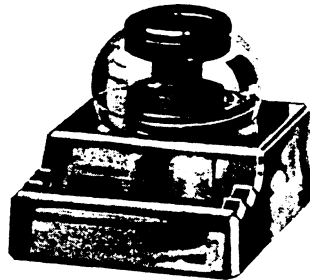

Above Illustrates No. 300

No. 300 — Single Desk Base, size 5 x 4 x 1 1/4 in., with one No. 56.
No. 301 — Double " " " 6 1/4 x 4 x 1 1/4 " " " No. 56.

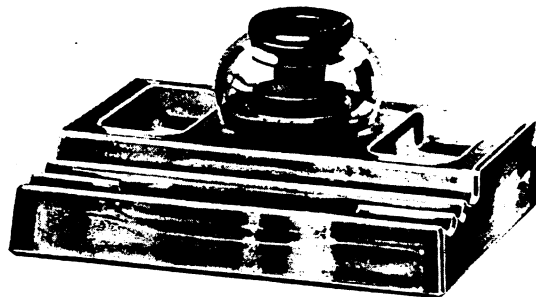

Above Illustrates No. 310

No. 310 — Single Desk Base, size 5 1/4 x 7 1/4 x 1 1/4 in., with one No. 56.
No. 311 — Double " " " 7 1/4 x 7 1/4 x 1 1/4 " " " No. 56.

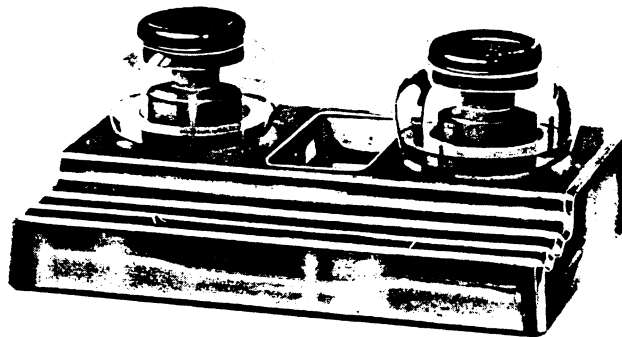

Above Illustrates No. 320

No. 320 — Single Desk Base, size 5 1/4 x 8 3/4 x 1 1/4 in., with two No. 56.
No. 321 — Double " " " 7 1/4 x 8 3/4 x 1 1/4 " " " No. 56.

NOTE — Wherever No. 56 is illustrated and listed with Bases, No. 60 may be substituted without extra cost; and No. 57 may be substituted at 50 cents additional for each Well.

Felt Mats with Pinked Edges may be had in Green, Brown and Maroon colors for all Bases on this page. See price list.

Sengbusch

No-Mar Rubber Base Sets



Bases Made of Flexible, Medium Hard, Colored Rubber. Cannot Scratch or Mar the Desk.

No-Mar Bases for No. 51 and No. 55 "Sengbusch" Inkstands.

The Bases listed below are with one Round Inkstand Receptacle in center, and one Pin Cup on each end.

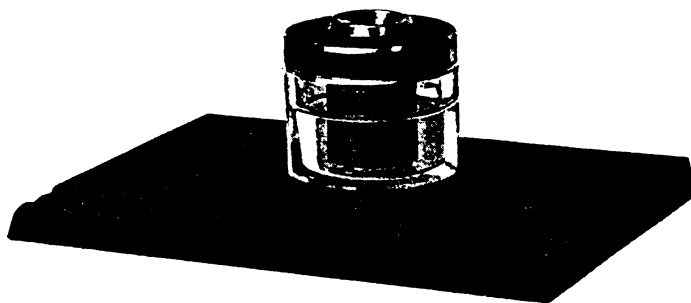

Above Illustrates No. 600 and No. 602 with One No. 51

No. 600	—	Brown	Base for	Single	Desk.	size	10¼	x	7½	x	¾	in.,	with	one	No. 51	or	No. 55.
No. 601	—	"	"	Double	"	"	10¼	x	8¾	x	¾	"	"	"	No. 51	"	No. 55.
No. 602	—	Green	"	"	Single	"	10¼	x	7½	x	¾	"	"	"	No. 51	"	No. 55.
No. 603	—	"	"	"	Double	"	10¼	x	8¾	x	¾	"	"	"	No. 51	"	No. 55.

The Bases listed below are with two Round Inkstand Receptacles and one Pin Cup in center.

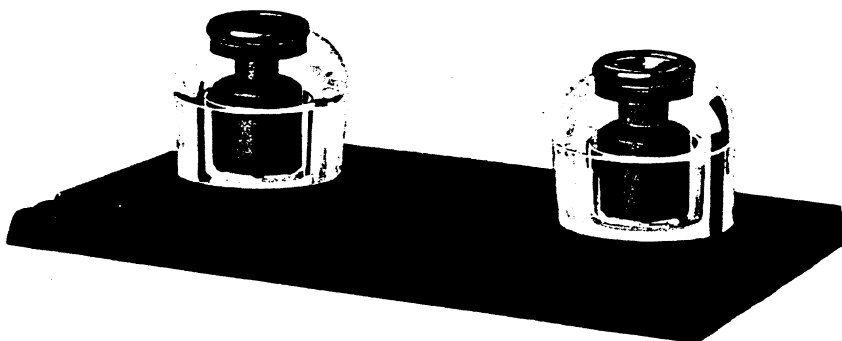

Above Illustrates No. 604 and No. 606 with Two No. 55

No. 604	—	Brown	Base for	Single	Desk.	size	13¼	x	7½	x	¾	in.,	with	two	No. 51	or	No. 55.
No. 605	—	"	"	Double	"	"	13¼	x	8¾	x	¾	"	"	"	No. 51	"	No. 55.
No. 606	—	Green	"	"	Single	"	13¼	x	7½	x	¾	"	"	"	No. 51	"	No. 55.
No. 607	—	"	"	"	Double	"	13¼	x	8¾	x	¾	"	"	"	No. 51	"	No. 55.

As the Nos. 51 and 55 Inkstands are the same diameter, the same Bases apply for both Inkstands. When ordering Sets, specify whether No. 51 or No. 55 Inkstand is wanted.



No-Mar Bases for No. 52 and No. 53 "Sengbusch" Inkstands.

The Bases listed below are with one Square Inkstand Receptacle in center and one Pin Cup on each end.

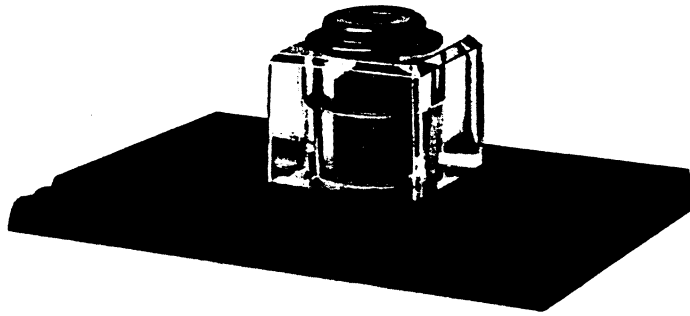

Above Illustrates No. 608 and No. 610 Double Desk with One No. 52

No. 608	—	Brown	Base for	Single	Desk,	size	10¼	x	7½	x	¾	in.,	with	one	No. 52	or	No. 53.
No. 609	—	"	"	"	Double	"	10¼	x	8¾	x	¾	"	"	"	No. 52	"	No. 53.
No. 610	—	Green	"	"	Single	"	10¼	x	7½	x	¾	"	"	"	No. 52	"	No. 53.
No. 611	—	"	"	"	Double	"	10¼	x	8¾	x	¾	"	"	"	No. 52	"	No. 53.

The Bases listed below are with two Square Inkstand Receptacles and one Pin Cup in Center.

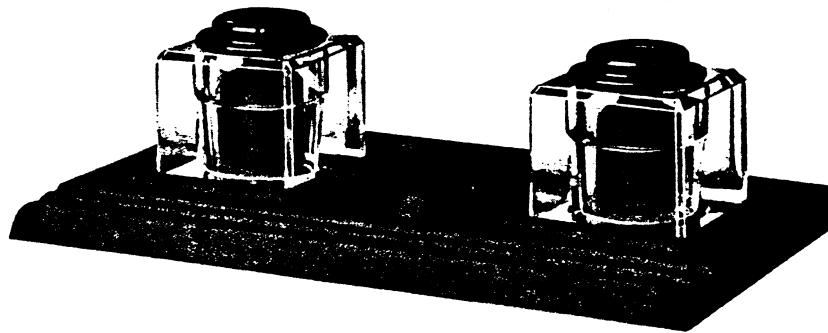

Above Illustrates No. 612 and No. 614 with Two No. 52

No. 612	—	Brown	Base for	Single	Desk,	size	13¼	x	7½	x	¾	in.,	with	two	No. 52	or	No. 53.
No. 613	—	"	"	"	Double	"	13¼	x	8¾	x	¾	"	"	"	No. 52	"	No. 53.
No. 614	—	Green	"	"	Single	"	13¼	x	7½	x	¾	"	"	"	No. 52	"	No. 53.
No. 615	—	"	"	"	Double	"	13¼	x	8¾	x	¾	"	"	"	No. 52	"	No. 53.

NOTE— Wherever No. 52 is illustrated and listed with Bases, No. 53 Plain Glass may be substituted at 25 cents less for each Well.

Sengbusch

No-Mar Rubber Base Sets

No-Mar Bases for No. 56, No. 57 and No. 60 "Sengbusch" Countersunk Inkstands.

The Bases listed below are with one Open Round Inkstand Receptacle in center and one Pin Cup on each end.

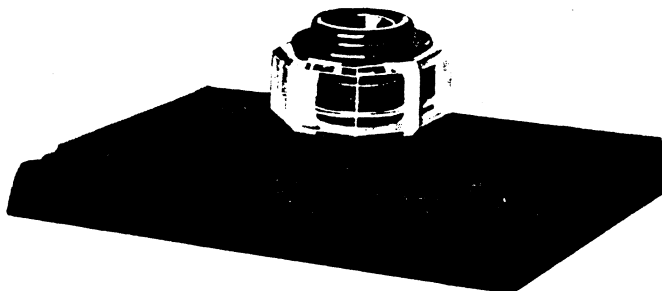

Above illustrates No. 616 and No. 618 with One No. 57

No. 616	—	Brown	Base for Single Desk,	size	$9\frac{3}{8} \times 7\frac{1}{2} \times \frac{7}{8}$	in.,	with one	No. 56	or	No. 57.
No. 617	—	"	"	"	Double	"	"	"	"	No. 56 " No. 57.
No. 618	—	Green	"	"	Single	"	"	"	"	No. 56 " No. 57.
No. 619	—	"	"	"	Double	"	"	"	"	No. 56 " No. 57.

The Bases listed below are with two Open Round Inkstand Receptacles and one Pin Cup in Center.

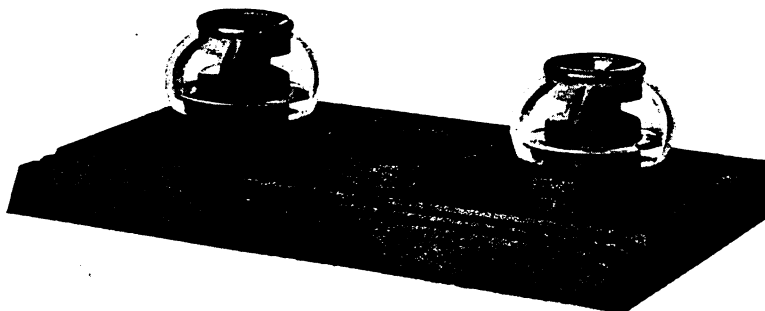

Above illustrates No. 620 and No. 622 with Two No. 56

No. 620	—	Brown	Base for Single Desk,	size	$11\frac{1}{8} \times 7\frac{1}{2} \times \frac{7}{8}$	in.,	with two	No. 56	or	No. 57.
No. 621	—	"	"	"	Double	"	"	"	"	No. 56 " No. 57.
No. 622	—	Green	"	"	Single	"	"	"	"	No. 56 " No. 57.
No. 623	—	"	"	"	Double	"	"	"	"	No. 56 " No. 57.

NOTE — Wherever No. 56 is illustrated and listed with Bases, No. 60 may be substituted without extra cost; and No. 57 may be substituted at 50 cents additional for each Well.

While the NO-MAR Rubber Inkstand Bases are here only listed in Brown and Olive Green colored rubber, yet where occasion demands it, these Bases may be made up in Special Colors. Submit sample of color desired and prices will be quoted promptly.

No-Mar Rubber Base Sets



No-Mar Bases for One Inkstand.

No Pin Cup in Base.

Made for Single Desk Only.

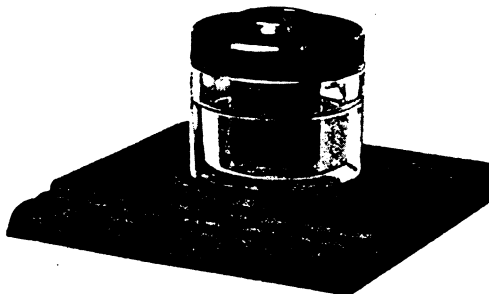

Above illustrates No. 624 and No. 626 with No. 51

No. 624 — Brown, for Single Desk, size $6\frac{1}{2} \times 6\frac{1}{2} \times \frac{5}{8}$ in., with one No. 51 or No. 55.
 No. 626 — Green, " " " $6\frac{1}{2} \times 6\frac{1}{2} \times \frac{5}{8}$ " " " No. 51 " No. 55.

As the Nos. 51 and 55 Inkstands are the same diameter, the same Bases apply for both Inkstands. When ordering Sets, specify whether No. 51 or No. 55 Inkstand is wanted.

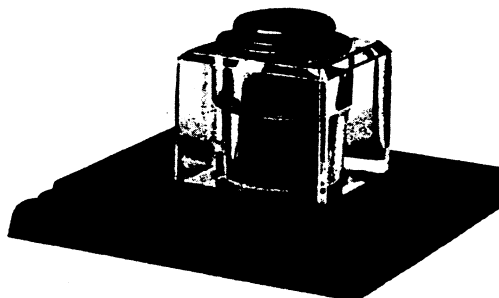

Above illustrates No. 628 and No. 630 with No. 52

No. 628 — Brown, for Single Desk, size $6\frac{1}{2} \times 6\frac{1}{2} \times \frac{5}{8}$ in., with one No. 52 or No. 53.
 No. 630 — Green, for " " " $6\frac{1}{2} \times 6\frac{1}{2} \times \frac{5}{8}$ " " " No. 52 " No. 53.

Wherever No. 52 is illustrated and listed with Bases, No. 53 plain glass may be substituted at 25 cents less for each Well.

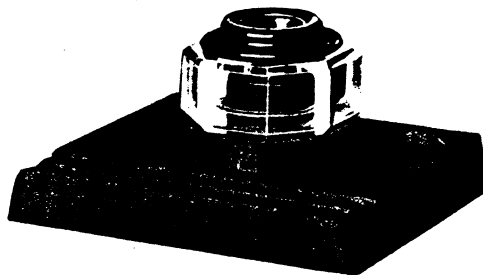

Above illustrates No. 632 and No. 634 with No. 57

No. 632 — Brown, for Single Desk, size $6\frac{1}{2} \times 6\frac{1}{2} \times \frac{7}{8}$ in., with one No. 56 or No. 57.
 No. 634 — Green, for " " " $6\frac{1}{2} \times 6\frac{1}{2} \times \frac{7}{8}$ " " " No. 56 " No. 57.

When ordering Sets, specify whether No. 56 or No. 57 is wanted. Wherever No. 56 is illustrated and listed with Bases, No. 60 may be substituted without extra cost.

Sonolus

White Cut and Pressed Glass Bases

For 3-inch and 3½-inch Square Inkstands (Nos. 52, 53 and 54) and 3-inch Round Inkstands (Nos. 51 and 55).

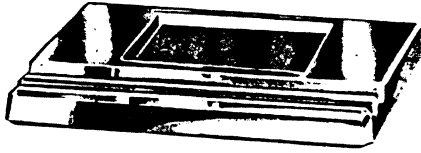

Above Illustrates Square Hole Nos. 230 and 232

- No. 230 — Cut Glass for Single Desk with one 3 in. Sq. Hole.
- No. 230a — " " " " " 3½ " " "
- No. 231 — " " " Double " " " 3 " " "
- No. 231a — " " " " " " 3½ " " "
- No. 232 — Pressed Glass for Single Desk with one 3 in. Sq. Hole.
- No. 232a — " " " " " 3½ " " "



Above Illustrates Round Hole, Nos. 234 and 236

- No. 233 — Pressed Glass for Double Desk with one 3 in. Sq. Hole.
- No. 233a — " " " " " 3½ " " "
- No. 234 — Cut Glass for Single Desk with one 3 in. Rd. Hole.
- No. 235 — " " " Double " " " 3 " " "
- No. 236 — Pressed Glass for Single Desk with one 3 in. Rd. Hole.
- No. 237 — " " " " Double " " " 3 " " "

Size of all the above Single Desk Bases 6¼ x 6¼ x ¾ in.
Size of all the above Double Desk Bases 7 x 6¼ x ¾ in.

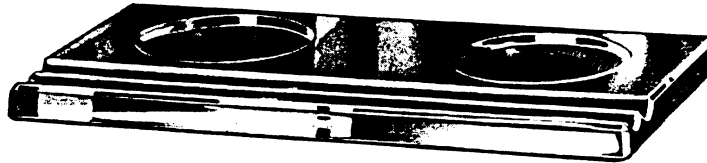

Above Illustrates Round Hole, Nos. 244 and 246

- No. 240 — Cut Glass for Single Desk with two 3 in. Sq. Holes.
- No. 240a — " " " " " 3½ " " "
- No. 241 — " " " Double " " " 3 " " "
- No. 241a — " " " " " " 3½ " " "
- No. 242 — Pressed Glass for Single Desk with two 3 in. Sq. Holes.
- No. 242a — " " " " " 3½ " " "
- No. 243 — Pressed Glass for Double Desk with two 3 in. Sq. Holes.
- No. 243a — " " " " " 3½ " " "
- No. 244 — Cut Glass for Single Desk with two 3 in. Rd. Holes.
- No. 245 — " " " Double " " " 3 " " "
- No. 246 — Pressed Glass for Single Desk with two 3 in. Rd. Holes.
- No. 247 — " " " " Double " " " 3 " " "

Size of all the above Single Desk Bases 6 x 11 x ¾ in.
Size of all the above Double Desk Bases 7 x 11 x ¾ in.

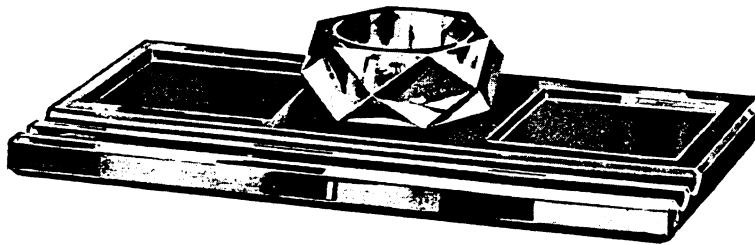

Above Illustrates Square Hole, Nos. 250 and 252

- *No. 250 — Cut Glass for Single Desk with two 3 in. Sq. Holes.
- *No. 250a — " " " " " 3½ " " "
- *No. 251 — " " " Double " " " 3 " " "
- *No. 251a — " " " " " " 3½ " " "
- †No. 252 — Pressed Glass for Single Desk with two 3 in. Sq. Holes.
- †No. 252a — " " " " " 3½ " " "
- †No. 253 — Pressed Glass for Double Desk with two 3 in. Sq. Holes.
- †No. 253a — " " " " " 3½ " " "
- *No. 254 — Cut Glass for Single Desk with two 3 in. Rd. Holes.
- *No. 255 — " " " Double " " " 3 " " "
- †No. 256 — Pressed Glass for Single Desk with two 3 in. Rd. Holes.
- †No. 257 — " " " " Double " " " 3 " " "

*Includes Cut Glass Pin Cup. †Includes Pressed Glass Pin Cup.

Size of all the above Single Desk Bases 6 x 11 x ¾ in.
Size of all the above Double Desk Bases 7 x 11 x ¾ in.

Felt Mats with Pinked Edges may be had in Green, Brown and Maroon colors for all Bases on this page. See price list.

Sengbusch's

Mucilage Applier



This simple device is the most practical way for the average person to use mucilage. It is made of flexible hard rubber. Illustrations shown below are self-explanatory.

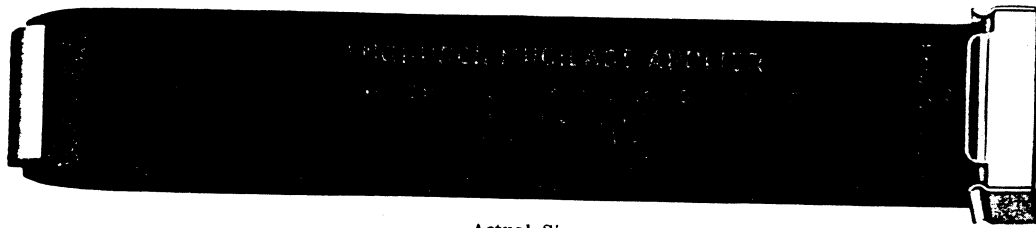

Actual Size.

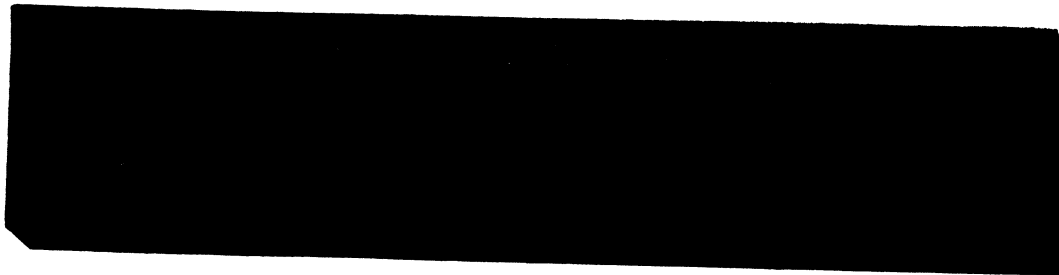

A Handy and Safe Box for carrying "Sengbusch" Mucilage Applier in your pocket or grip — 25 cents extra.

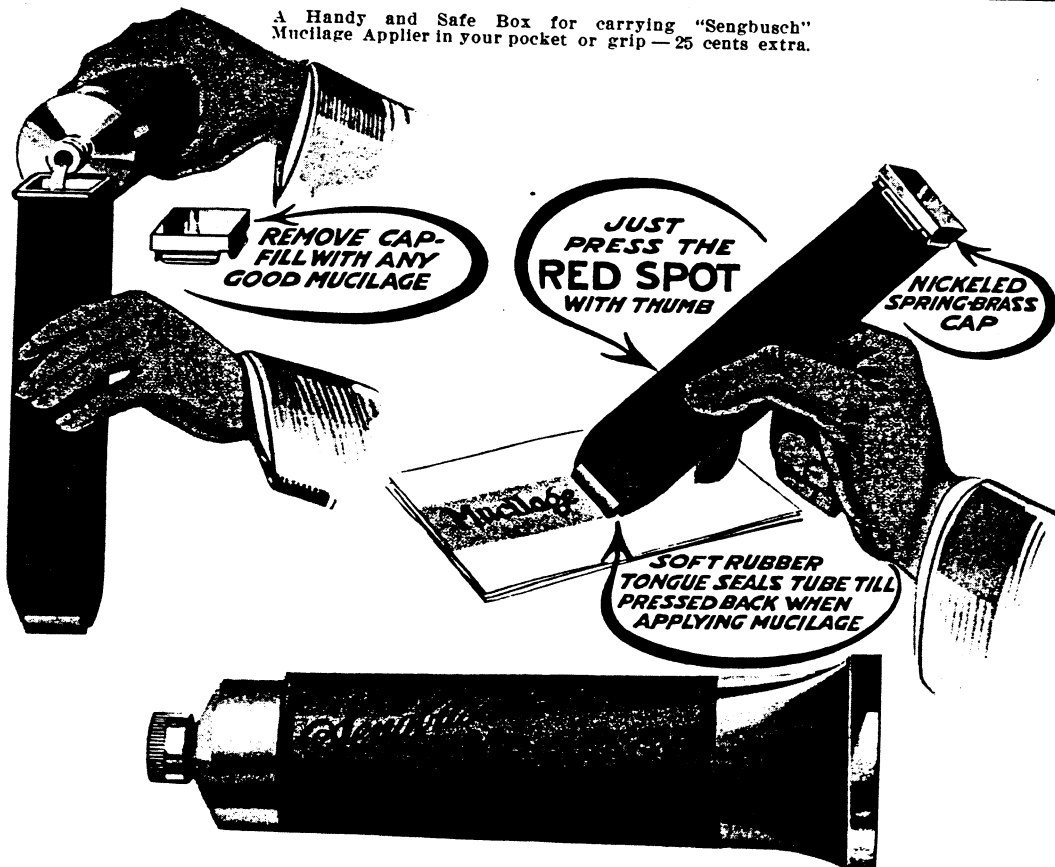

Specially put up for the Sengbusch Mucilage Applier, in $\frac{1}{2}$ and 1 ounce Collapsible Tubes.

The Handy Way to Apply Mucilage.
For Office — For Home Writing Desk — Traveling.

Sambasch

Ideal Sanitary Moistener



Here's a Moistener for fingers, postage stamps, gummed labels, envelope flaps, etc., that applies the right amount of moisture, quickly, surely and easily. It is sanitary and efficient. The wheel revolves without resistance or noise. Nothing to wear out, no rubber to harden or become useless; no wicks, felt or gauze to fill up. Made of glazed white porcelain with nickel polished metal parts. Rubber knobs securely fastened to bottom prevent scratching of desk tops or slipping on slanting surfaces.

Its Excellence Explains Its Almost Universal Use

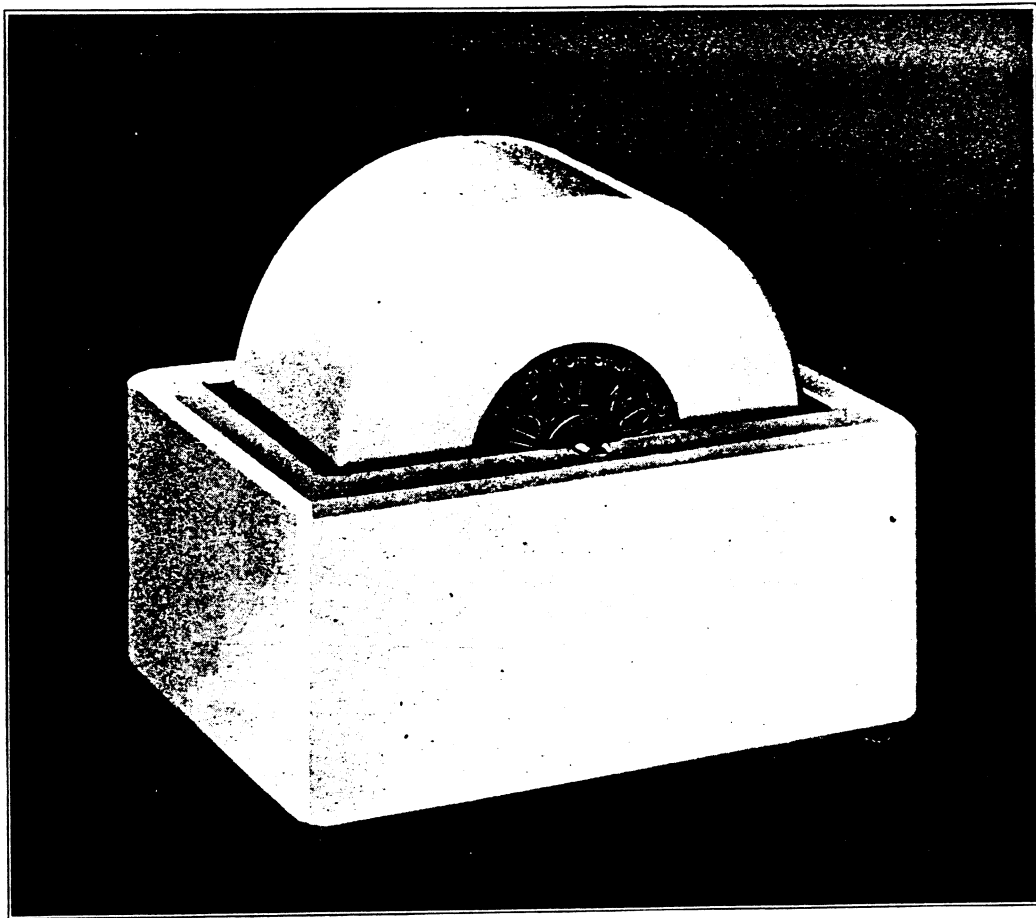

No need to warn you against licking of gummed paper. Gum* is made of skins, hoofs and other filth, and collects dirt constantly. Don't put it in your mouth.

Do It "The Quick and Easy Way" with an Ideal

*Glue — Made by boiling to a jelly animals' skins, hoofs, etc. (Dictionary.)

Sengbusch

No-Over-Flo Sponge Cup



Just what the name implies! No slopping nor splashing over on furniture or papers when sponge is pressed! An inner chamber takes care of the overflow. Liquid flows back into sponge when pressure is released.

The Sengbusch No-Over-Flo Sponge Cup is made in both Crystal glass and Opal glass of attractive design — illustrated. Its broad base and substantial weight (28 ounces) keep it firm and steady. The No-Over-Flo is not easily upset nor pushed out of place when in use.

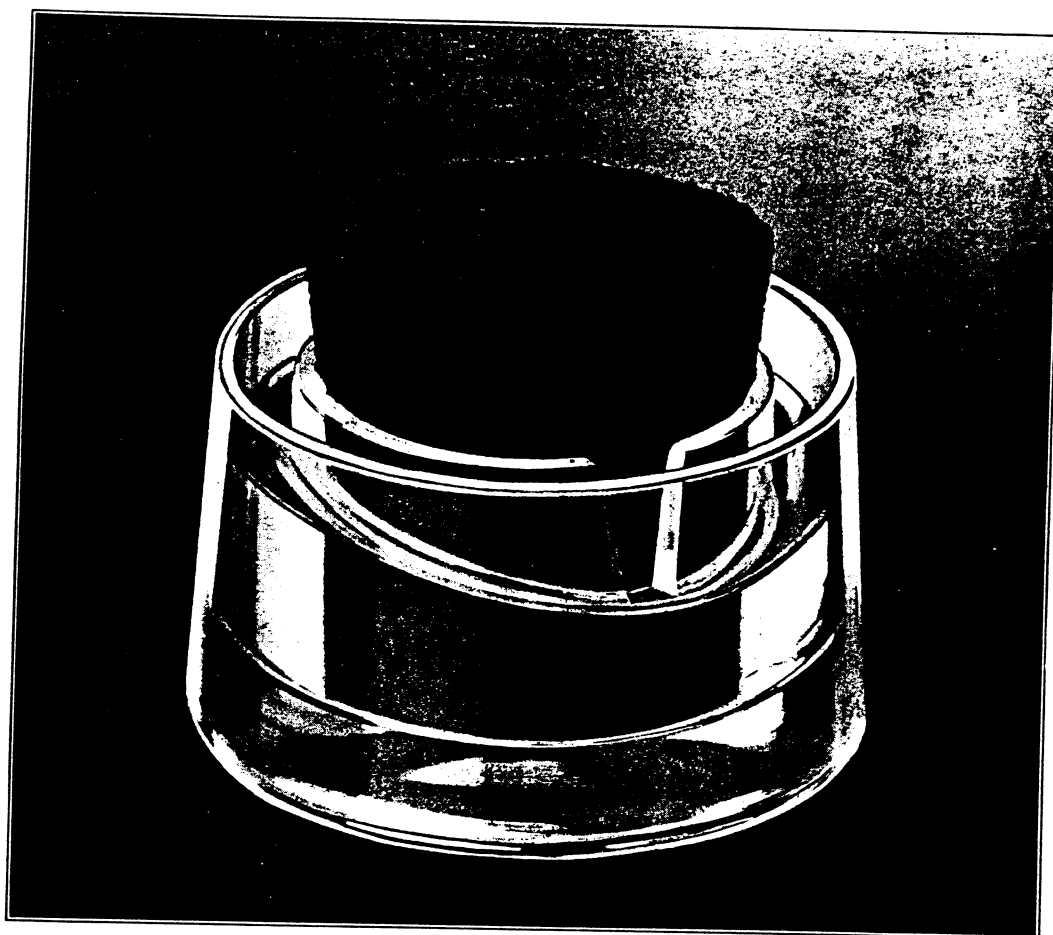

No. 1 Crystal Glass — No. 5 Opal Glass

The Sengbusch close-fitting sponge stays firmly in place with just enough projecting to make it handy to use. Made of live red rubber of exceptional fineness of texture, it retains moisture and reduces evaporation to a minimum. If preferred, a natural sponge of the proper size may be used with satisfaction.

Emmerich's

Emeraline Desk Accessories



All made of Selected Quality Plate Glass—Hand Cut and Highly Polished.

Paper Weights



No. 510



No. 513

- No. 510 — Round, with the Top Star Cut and Beaded.
 No. 511 — " " " " not Beaded.
 No. 512 — Round, with Polished Top and Bottom, Star Cut Top, Ground Sides.
 No. 513 — " " " " " without Star Cut Top. Ground Sides.

Size of above 1 inch thick, 2 inch diameter.

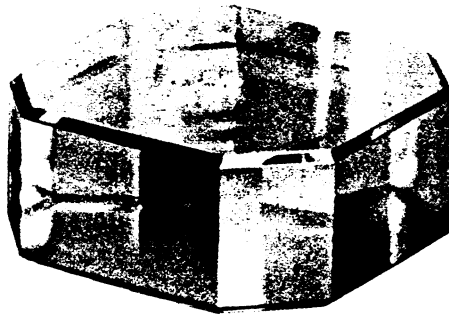

No. 520

- No. 520 — Octagon, Size 3 x 3 in., 1 1/4 in. thick.
 No. 521 — " " 3 x 3 " 1 " "
 No. 522 — " " 3 x 3 " 3/4 " "



No. 530

- No. 530 — Size 3 x 5 in., Concave, 1 1/4 in. thick.
 No. 531 — " 3 x 5 " " 1 " "
 No. 532 — " 3 x 5 " " 3/4 " "
 No. 533 — " 2 1/4 x 4 " " 1 1/4 " "
 No. 534 — " 2 1/4 x 4 " " 1 " "
 No. 535 — " 2 1/4 x 4 " " 3/4 " "



No. 540

- No. 540 — Size 3 x 5 in., Plain Top, 1 1/4 in. thick.
 No. 541 — " 3 x 5 " " " 1 " "
 No. 542 — " 3 x 5 " " " 3/4 " "
 No. 543 — " 2 1/4 x 4 " " " 1 1/4 " "
 No. 544 — " 2 1/4 x 4 " " " 1 " "
 No. 545 — " 2 1/4 x 4 " " " 3/4 " "



All made of Selected Quality Plate Glass — Hand Cut and Highly Polished.

Pen and Pencil Racks.



Made of $\frac{1}{2}$ In. Plate Glass
No. 550 — Size 2 x 8 in.

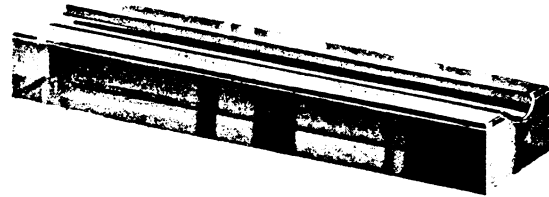

Made of 1 In. Plate Glass
No. 551 — Size $2\frac{1}{4}$ x 8 in.

Emeraline Ash Trays with Brass Match Holder.

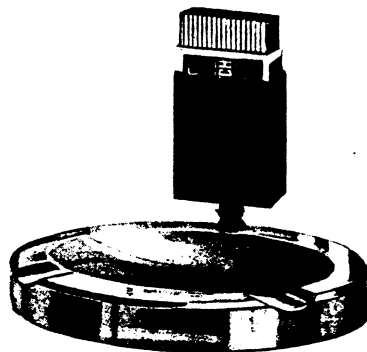

Made of $\frac{3}{4}$ In. Plate Glass
No. 565 — Oval. Size 4 x $5\frac{1}{2}$ in.

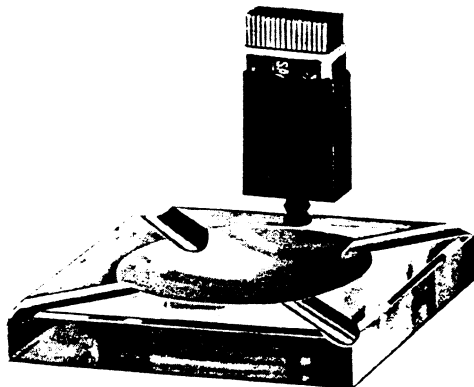

Made of 1 In. Plate Glass
No. 560 — Square. Size 5 x 5 in.

In addition to the items on this page and the preceding page, we can make up of Emeraline Plate Glass any other designs you may want for your desk. Simply give us the drawing and dimensions of what you want.

Spencer

Kleradesk

Clears Your Desk for Clear Thinking.

Made of interchangeable, vertical, steel sections. Extra sections can be added as needed or complete models can be purchased with any number of compartments.

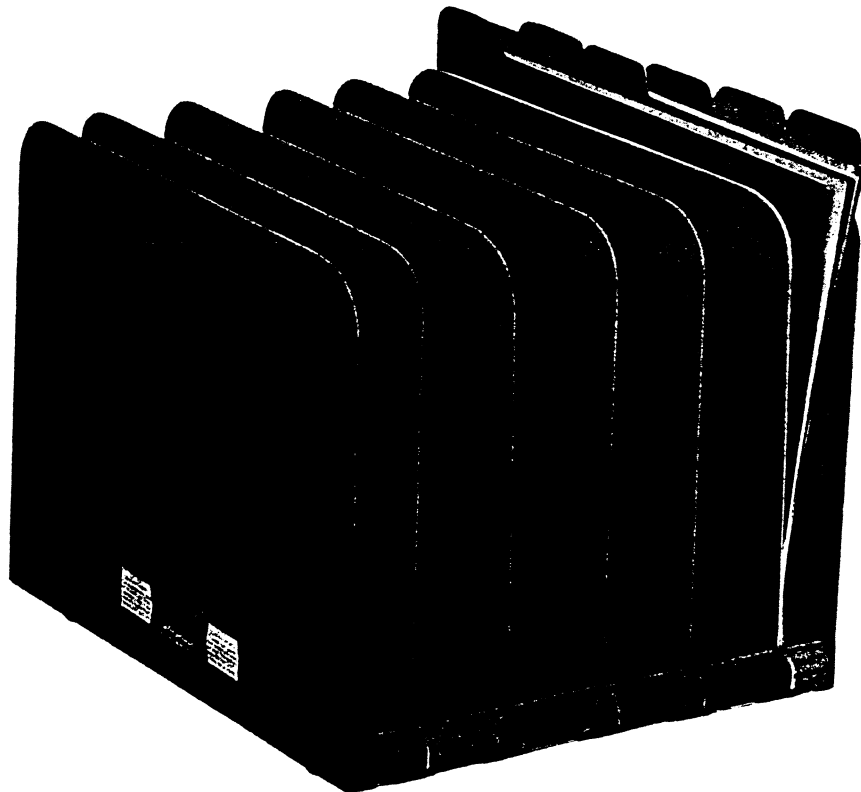

Above illustrates Model 6V in Green, with "Daily Reminder" Folders. Requires less space than wire basket or wooden tray.

It is a six-compartment equipment and is made up with two end and five center sections. It is an extremely popular model, its six compartments being adaptable to the needs of practically every business man's desk. The "Daily Reminder" Colored Signal Folders, shown in the above Model, are an exceptionally valuable feature. One merely lifts out each day's folder and it calls to one's attention the papers and work that should be attended to during the day.

Eight Interchangeable Steel Sections.

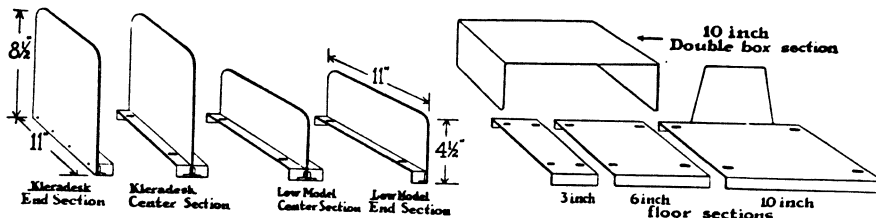

Above is a diagram illustration of the eight standard Kleradesk sections from which any kind of a Kleradesk model may be assembled. All sections are made of sheet steel and fastened together by a "combination bolt and bumper-foot" — no tools required. High and low sections can be used together when desired. Floor flanges, on end and center sections, make compartments adjustable from 1 inch to 1 3/4 inches between uprights. The 3-inch, 6-inch and 10-inch floor sections are not required for regular Kleradesk equipment, but are provided to meet the demand for extra wide compartments. The 10-inch floor section is for flat filing and has a back piece that prevents papers from falling out. When two 10-inch spaces are desired, the 10-inch Double Box Section should be ordered with a single 10-inch floor section. All compartments can be indexed front and back.

Kleradesk may be had in either Oak, Mahogany, Walnut or Olive Green Finish.



Prevents Confusion and Gives You Greater Desk Efficiency.

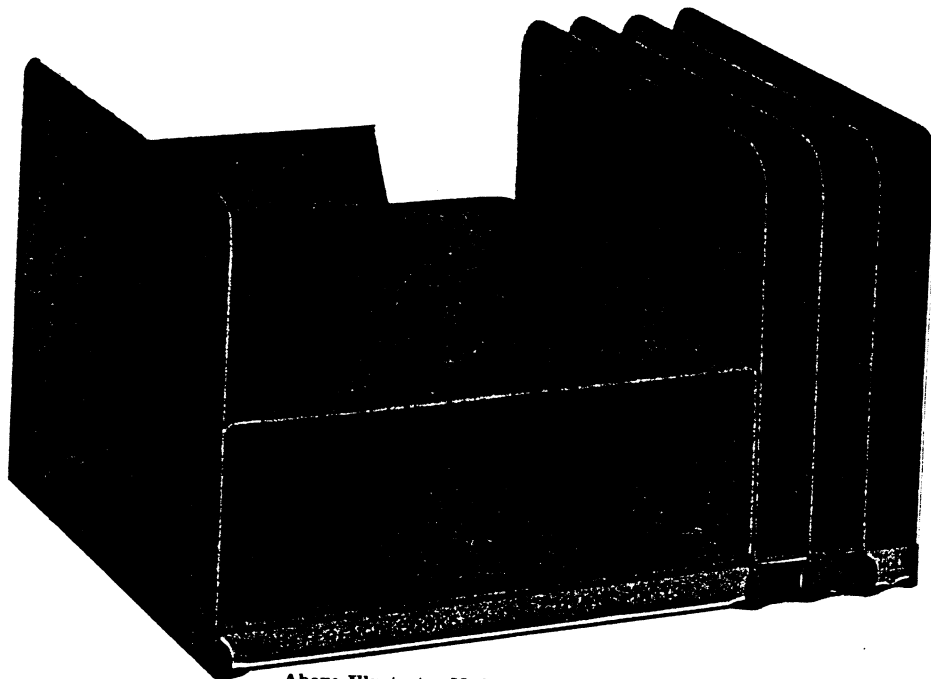

Above Illustrates Model D, in Oak.

Kleradesk will help every Executive, Clerk and Stenographer to better organize their desk work along the following lines:

1. More convenient temporary holding of matters that cannot be disposed of at once.
2. Quicker and automatic dispatching of papers to be distributed to others.
3. Greater convenience in holding permanent reference matters for instant availability.

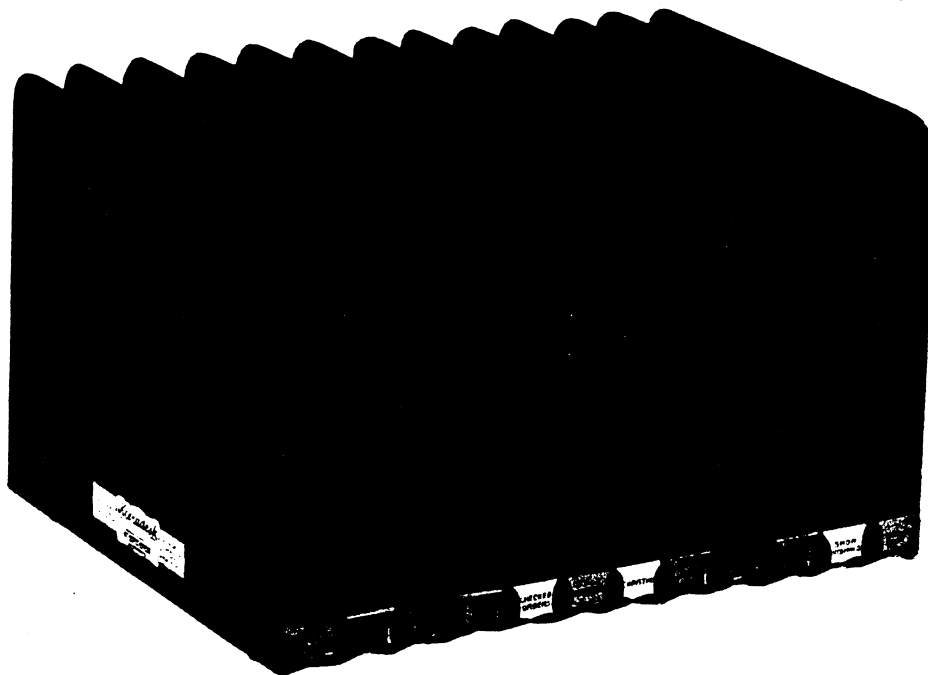

Above Illustrates Model 12V in Mahogany.

The Most Flexible Desk Distributor Ever Invented.



Placing papers in labeled compartments, automatically routes and instructs messenger where to deliver.

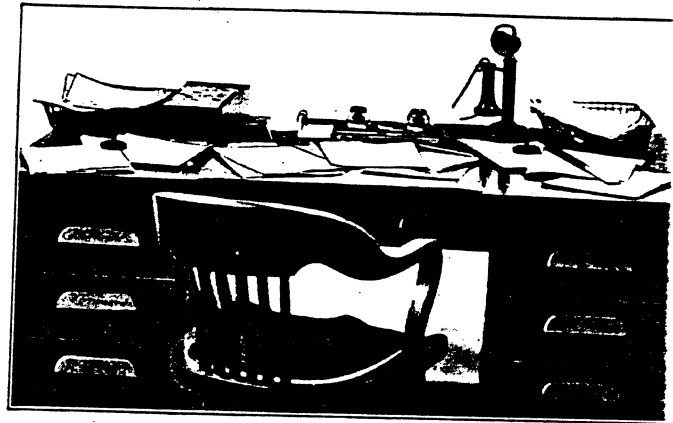

Every paper on this desk is in Kleradesk on opposite desk.



Low model for checks, currency, memos, etc.

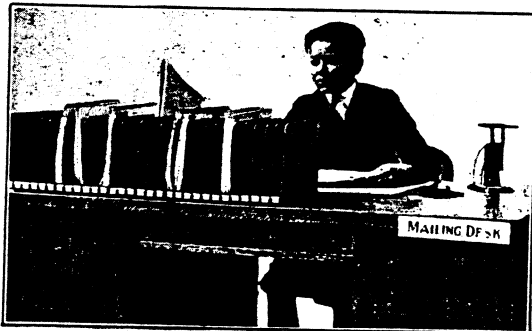

30 compartments use less space than 3 baskets.



Use Kleradesk for preliminary sorting — one compartment for each drawer — will save 20 per cent of filing time.

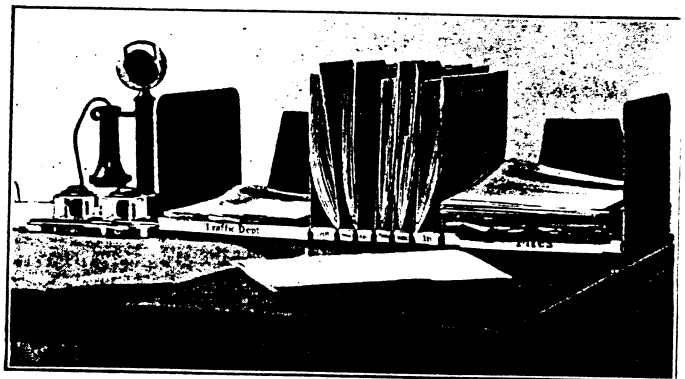

Combining both flat and vertical handling of letters, it fits into your present desk system.

Kleradesk

1. Clears your desk for action.
2. Prevents confusion of papers.
3. Relieves you from constantly shuffling and reshuffling letters.
4. Saves time and labor sorting, classifying, and temporary holding of current papers.
5. Automatically distributes letters and memos to others in your organization.
6. Holds, ready for quick reference, catalogues, price lists, telephone books, trade journals, etc.
7. Saves space on top of desk, which is most valuable space in your office.

Low Model Kleradesk

For Checks, Currency and General Sorting.

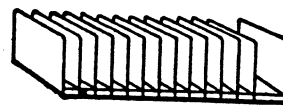

Model F — For Vertical Sorting.

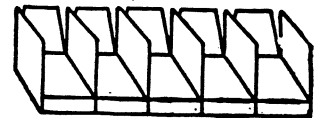

Model S-H — For Flat Sorting.



Model E — Steel Desk Tray.

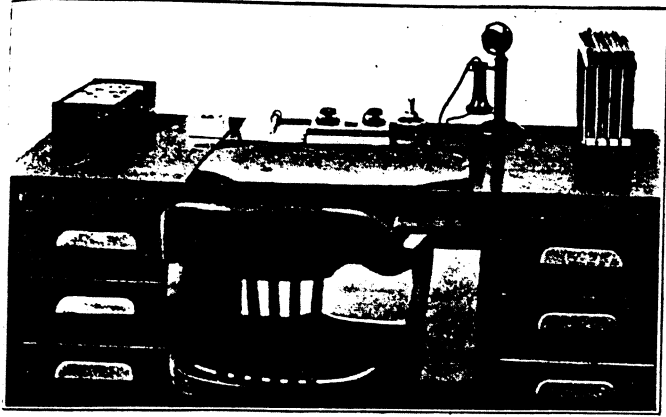

This small Kleradesk contains every paper on opposite desk.



Small stenographers' desks, made roomy, develop efficiency.

These models are shipped assembled. They are made of interchangeable steel sections. Extra sections can be added as needed. The diagrams will give you an idea of the many different assemblages that can be secured with the various Kleradesk sections.

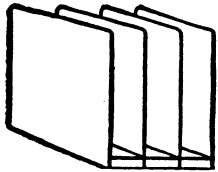

Model 3-V

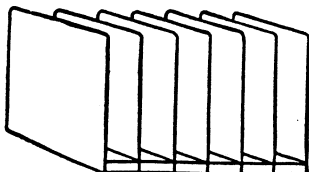

Model 6-V

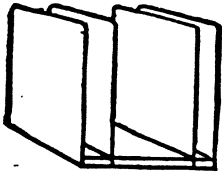

Model C

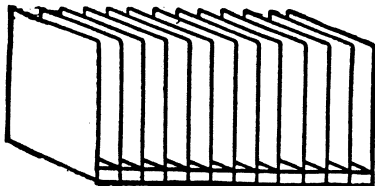

Model 12-V

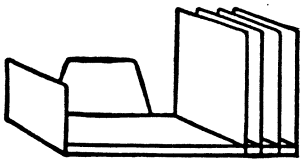

Model A

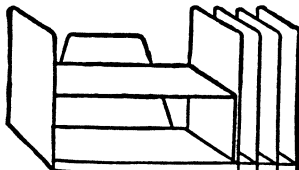

Model D

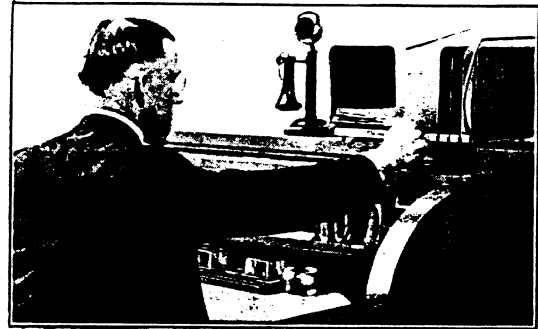

Easy to use on every type of desk.



Papers filed vertically in Kleradesk will not be blown away.

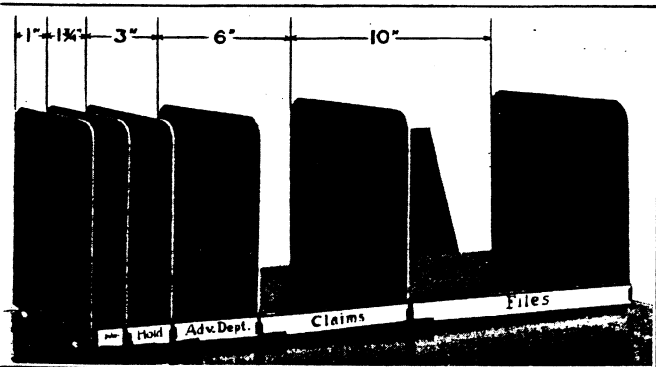

Compartments of any width.

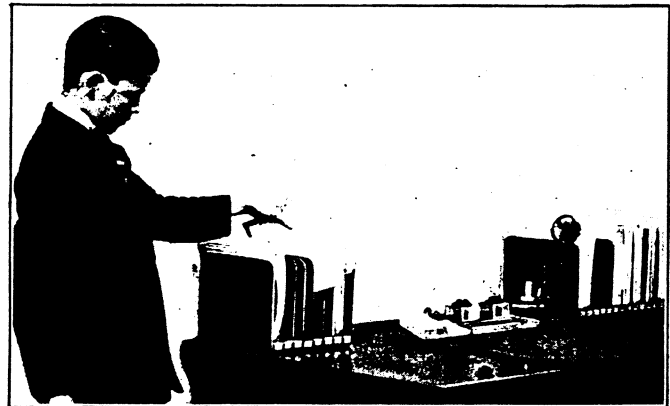

One for distributing — one for holding papers.

Sengbusch

INDEX

	Page		Page
Ash Trays—Emeraline Plate Glass.....	27	Mahogany Standard Bases with Nos. 56, 60 and 62 Inkstands...	15
Black Plate Glass Bases with No. 57 Inkstand.....	6	Mahogany Standard Bases with Nos. 51, 52 and 53 Inkstands...	16
Black Plate Glass Bases (Oval) with No. 57 Inkstand.....	7	Mucilage Applier	23
Box for Carrying Mucilage Applier.....	23	Mucilage	23
Emeraline Plate Glass Bases, with No. 52 Inkstand.....	5	No-Mar Rubber Bases with Nos. 51 and 55 Inkstands.....	18
Emeraline Plate Glass Bases, with No. 57 Inkstand.....	6	No-Mar Rubber Bases with Nos. 52 and 53 Inkstands.....	19
Emeraline Plate Glass Bases, (Oval) with No. 57 Inkstand.....	7	No-Mar Rubber Bases with Nos. 56, 57 and 60 Inkstands.....	20
Emeraline Plate Glass Bases, (Oval) (One, 1-inch Pen Groove) with No. 57 Inkstand.....	8	No-Mar Rubber Bases with Nos. 51, 52, 53, 56, 57 and 60 Inkstands	21
Emeraline Plate Glass Bases (Oval) with No. 52 Inkstand.....	9	No-Over-Flo Sponge Cup.....	25
Emeraline Plate Glass Bases, (Cut off Corners) with Nos. 52 and 57 Inkstand	10	Oak Colonial Bases with Nos. 52 and 53 Inkstand.....	13
Emeraline Plate Glass Bases, (4½ inches wide) with Nos. 52 and 57 Inkstands	11	Oak Colonial Bases with No. 57 Inkstand.....	14
Emeraline Plate Glass Bases, (½ inch thick) with Nos. 51 and 56 Inkstands	12	Oak Standard Bases with Nos. 56, 60 and 62 Inkstands.....	15
Emeraline Plate Glass Bases, (1½ inch thick) with No. 57 Inkstand	12	Oak Standard Bases with Nos. 51, 52 and 53 Inkstands.....	16
Felt Mats for All Glass Bases.....	5-12, 17 and 22	Paper Weights—Emeraline Plate Glass.....	26
Ideal Moistener	24	Pen and Pencil Trays—Emeraline Plate Glass.....	27
Inkstands	4	People Who Pass Your Door.....	32
Kleradesk with Description.....	28	Pressed Glass Bases with Nos. 56, 57 and 60 Inkstands.....	17
Kleradesk, Illustration of Large Models.....	29	Sectional View	3
Kleradesk, in Pictures of Actual Service.....	30 and 31	"Good Reasons" for the "Sengbusch" Inkstand.....	3
Kleradesk, Various Assemblages of Models.....	30 and 31	"Sengbusch" Service	2
Mahogany Colonial Bases with Nos. 52 and 53 Inkstands.....	13	Single Inkstands Nos. 51 to 64 inclusive, with descriptions.....	4
Mahogany Colonial Bases with No. 57 Inkstand.....	14	Title Page	1
		Walnut Colonial Bases with Nos. 52 and 53 Inkstand.....	13
		Walnut Colonial Bases with No. 57 Inkstand.....	14
		White Cut and Pressed Glass Bases for Nos. 51, 52, 53, 54 and 55 Inkstands	22

NOTE—Always keep a Price List in the Pocket provided for it in the Back Cover.

The People Who Pass Your Door

Possibly men — just the men who would be interested in "Sengbusch" products are passing your door every day. It is a matter of arresting their attention. It doesn't matter whether they are from upper Main Street or pass your door through the medium of the postman. You are interested, of course, in the man who comes in, but it is the man who passes that takes your profits with him — his trade.

These people must be reached, and we study this from every angle and render the service to dealers that is most helpful.

There is an abundance of evidence that people want the "Sengbusch" products. It is largely a question of good window display and proper publicity. The "Sengbusch" dealers who take on our line will fully appreciate how effectively we work with them to make sales.

Won't you ask our Sales and Advertising Department to help you?

SENGBUSCH SELF-CLOSING INKSTAND CO.
MILWAUKEE, WISCONSIN, U. S. A.

Supplement No. 1 to

Sengbusch

Catalog
No. 20

With Prices Effective June 1, 1925



Sengbusch Self-Closing
Inkstand Company
Milwaukee, Wisconsin, U.S.A.

Scribner

Daily Perpetual Desk Calendar Sets



High-Grade Cut and Polished Emeraline Plate Glass — Hand Cut and Highly Polished.

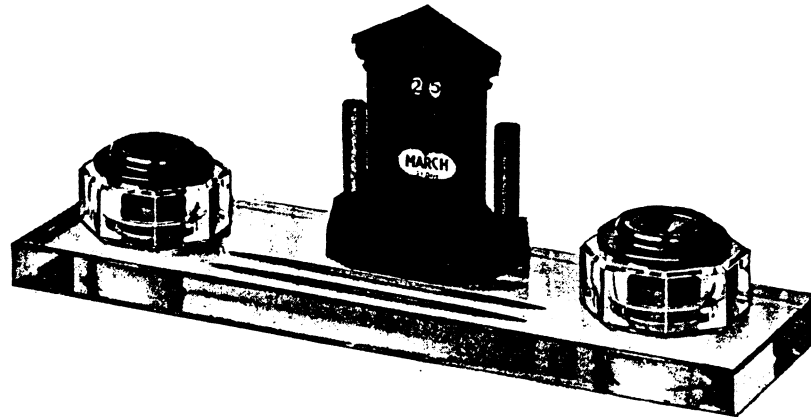

No. 800 — Single Face, with two No. 57 Inkstands and Cast Metal, Mahogany Finish, Daily Perpetual Calendar..... \$22.00
 Price Complete
 Size of Base 16 x 4½ x 1 in. — Height of Calendar 5½ in.

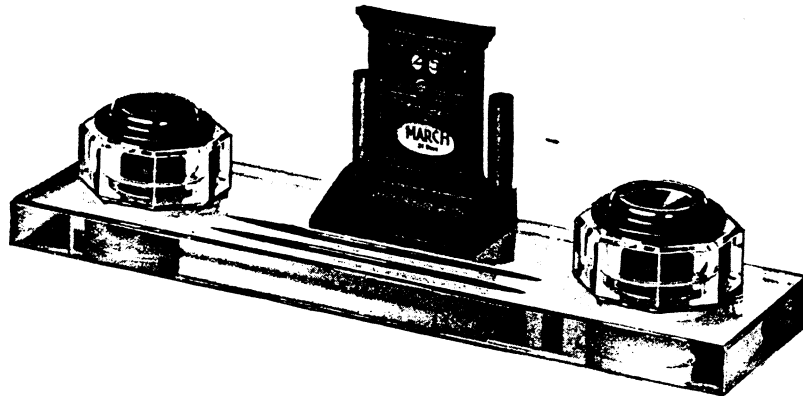

No. 805 — Single Face, with two No. 57 Inkstands and Cast Metal, Verde Antique Finish, Daily Perpetual Calendar..... \$21.00
 Price Complete
 Size of Base 16 x 4½ x 1 in. — Height of Calendar 4½ in.

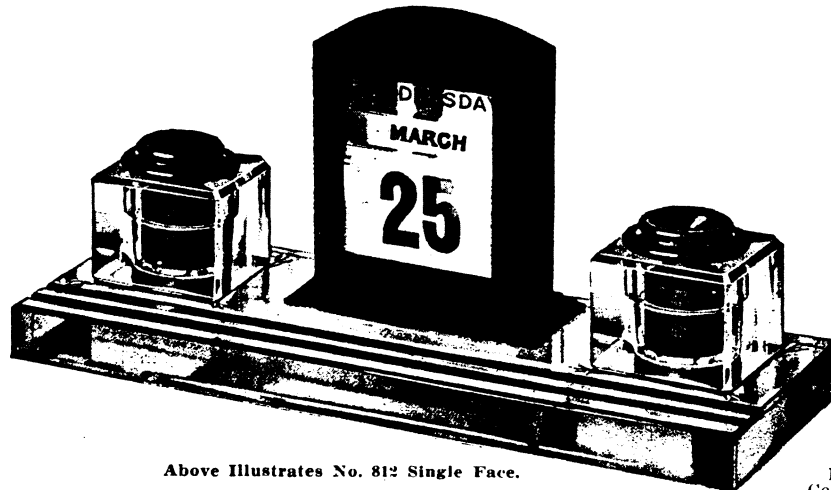

Above Illustrates No. 812 Single Face.

No. 810 — Single Face, with two No. 52 Inkstands and Oak Finish Daily Perpetual Calendar..	\$25.00
No. 811 — Double " " " No. 52 " " " " " " " " " " " "	.. 30.00
No. 812 — Single " " " No. 52 " " Mah. " " " " " " " "	.. 26.00
No. 813 — Double " " " No. 52 " " " " " " " " " " " "	.. 31.00
No. 814 — Single " " " No. 52 " " Wal. " " " " " " " "	.. 27.00
No. 815 — Double " " " No. 52 " " " " " " " " " " " "	.. 32.00

Size of Single Face Base 16 x 6 x 1¼ in. — Height of Calendar 6¼ in.
 Size of Double Face Base 16 x 7½ x 1¼ in. — Height of Calendar 6¼ in.

Super-Colonial Base Sets



Mahogany and Walnut Base Sets, with No. 52M Cut Glass Inkstand.

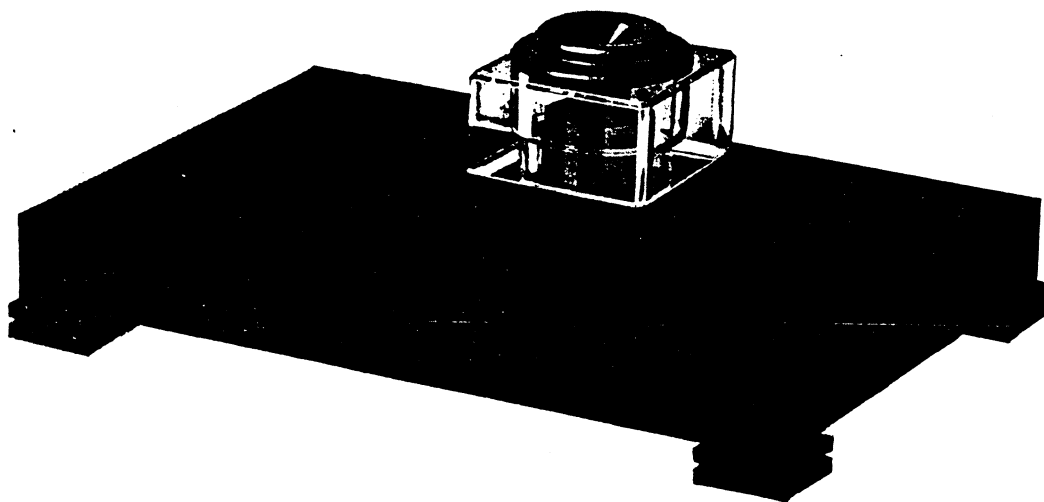

No. 702 — Mahogany Base for Single Desk with one No. 52M.....	Set Complete	\$17.50	Base Only	\$15.00
No. 705 — Walnut " " " " " " " " " " " " No. 52M.....		17.50		15.00

Size of Base 8 x 12 x 1¾ in.

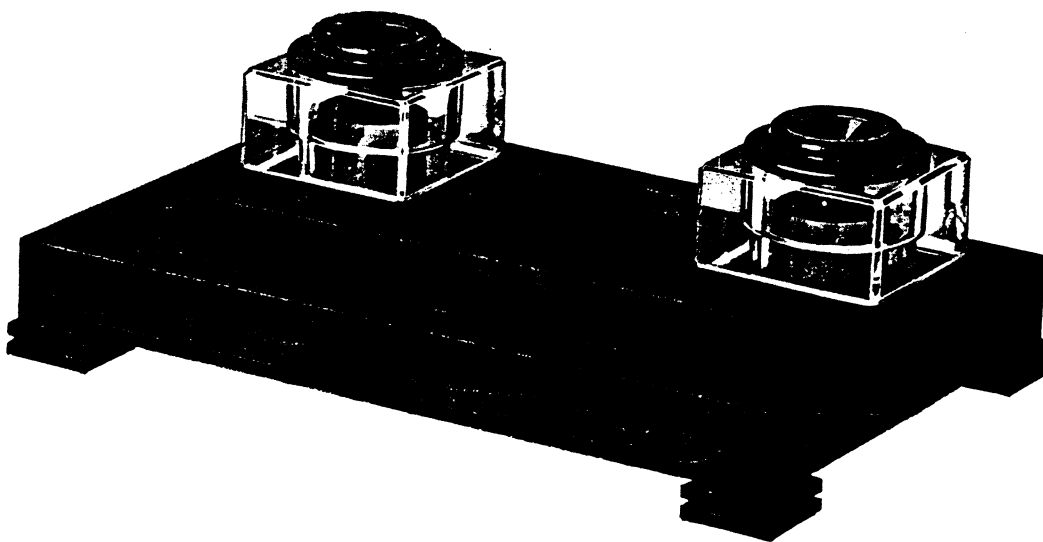

No. 722 — Mahogany Base for Single Desk with two No. 52M.....	Set Complete	\$20.00	Base Only	\$15.00
No. 725 — Walnut " " " " " " " " " " " " No. 52M.....		20.00		15.00

Size of Base 8 x 12 x 1¾ in.

These High-class Bases are made in One Piece, Solid Mahogany and Solid Walnut. Rich and Massive in appearance, and in keeping with the Highest Grade Office Furniture.

No-Over-Flo Sponge Cup



Just What the Name Implies!

No slopping or splashing over on furniture and papers when sponge is pressed — inner chamber takes care of over-flow. Liquid flows back into sponge when pressure is released.

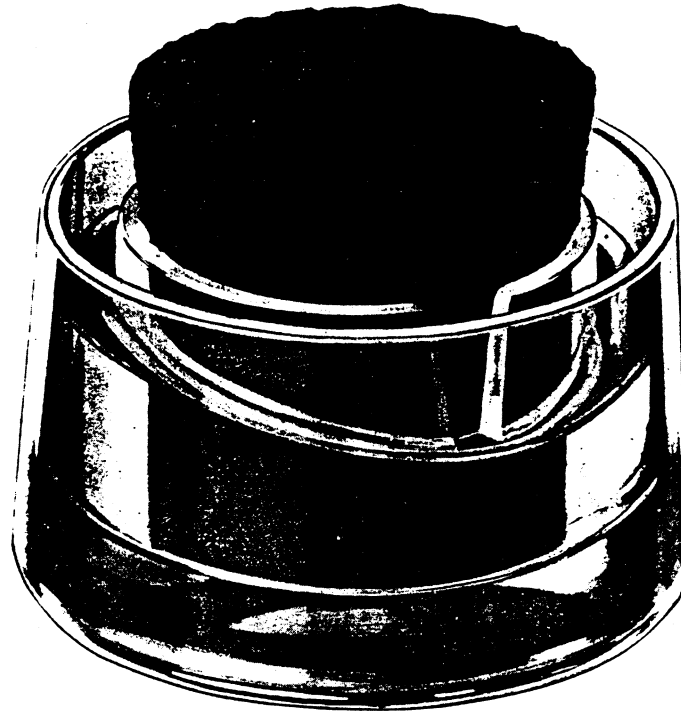

	With Sponge	Cup Only
No. 1 — Crystal Glass.....	\$1.00 Each	\$0.75 Each
No. 5 — Opal Glass.....	1.25 "	1.00 "
Red Rubber Sponge used in above.....		.25 "
Size 4¼ in. diameter x 2½ in. high.		

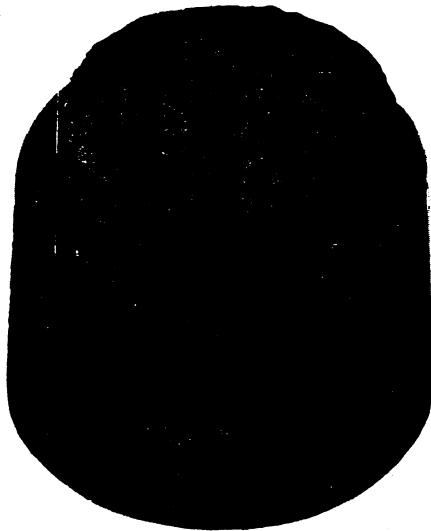

No. 10 — Maroon Composition.....
Red Rubber Sponge used in above..
Size 3¼ in. diameter x 2½ in. high.

With Sponge
\$0.75 Each

Cup Only
\$0.55 Each
.20 "



No. 11 — Green

With Sponge
\$0.75 Each

Cup Only
\$0.55 Each
.20 "

Handy, Neat, Firm and Solid.

The No-Over-Flo is not easily upset nor pushed out of place when in use. Its broad base and substantial weight keep it firm and steady. The Sengbusch close-fitting sponge stays firmly in place with just enough projecting to make it handy to use. Made of live red rubber of exceptional fineness of texture, it retains moisture and reduces evaporation to a minimum. If preferred, a natural sponge of the proper size may be used with satisfaction.